DIY Neuroscience Kit Pro

Upside Down Labs

Jan 01, 2025

CONTENTS

1	DIY Neuroscience Kit Pro	1
1.1	Contents of the kit	2
1.2	Software requirements	3
1.3	Using the kit	3
1.3.1	Step 1: Using BioAmp EXG Pill	3
1.3.2	Step 2: Using Muscle BioAmp Shield	4
1.3.3	Step 3: Using the sensors together	5
1.4	Some project ideas	15
1.4.1	Projects made using BioAmp EXG Pill	15
1.4.2	Projects made using Muscle BioAmp Shield	15
1.4.3	Projects made using the sensors together	15
2	BioAmp EXG Pill	16
2.1	Overview	16
2.2	What makes it different?	17
2.3	Features & Specifications	17
2.4	Board layout	17
2.4.1	BioAmp EXG Pill is fully configurable	17
2.5	Software requirements	19
2.6	Using the Hardware	20
2.6.1	Step 1: Solder Connectors	20
2.6.2	Step 2 (optional): Configure for ECG/EMG	20
2.6.3	Step 3: Connect MCU/ADC	22
2.6.4	Step 4: Connecting electrode cable	22
2.6.5	Step 5: Skin Preparation	23
2.6.6	Step 6: Measuring ElectroMyoGraphy (EMG)	23
2.6.7	Step 6: Measuring ElectroCardioGraphy (ECG)	25
2.6.8	Step 7: Measuring Electrooculography (EOG)	27
2.6.9	Step 8: Measuring Electroencephalography (EEG)	29
2.7	Glimpses of previous versions	33
2.8	Real-world Applications	33
2.9	Project ideas & tutorials	33
2.10	Software tutorials	34
3	Muscle BioAmp Shield	35
3.1	Overview	35
3.2	Features & Specifications	36
3.3	Hardware	36
3.4	Contents of the kit	38
3.5	Software requirements	38
3.6	Using the Sensor	40
3.6.1	Step 1: Stack on Arduino Uno	40
3.6.2	Step 2: Connecting Electrode Cable	41
3.6.3	Step 3: Skin Preparation	41

3.6.4	Step 4: Electrode Placements	41
3.6.5	Step 5: Connect Arduino UNO to your laptop	43
3.6.6	Step 6: Visualise EMG signals on laptop	44
3.6.7	Step 7: Visualise EMG signals on LEDs	44
3.6.8	Step 8: Listen to your EMG signals	45
3.6.9	Step 9: Controlling a servo motor	45
3.6.10	Step 10: Controlling a servo claw	47
3.6.11	Step 11: Connecting 9V battery	47
3.6.12	Step 12: Other functionalities you can explore	48
4	Skin Preparation Guide	49
4.1	Why skin preparation is important?	49
4.2	Kit Contents	49
4.3	Steps to follow	50
4.3.1	Step 1: Identify the targeted area	50
4.3.2	Step 2: Apply NuPrep gel	50
4.3.3	Step 3: Clean the skin surface	50
4.3.4	Step 4: Wipe off the gel	54
4.3.5	Step 5: Measuring the signals	54
5	Using BioAmp Bands	57
5.1	Overview	57
5.2	Why use BioAmp Bands?	57
5.3	Types of BioAmp Bands	57
5.3.1	1. Muscle BioAmp Band	58
5.3.2	2. Heart BioAmp Band	58
5.3.3	3. Brain BioAmp Band	59
5.4	Using Muscle BioAmp Band	60
5.4.1	Assembly	60
5.4.2	Skin Preparation	62
5.4.3	Measure EMG	62
5.5	Using Heart BioAmp Band	64
5.5.1	Skin Preparation	64
5.5.2	Assembly	64
5.5.3	Measure ECG	66
5.6	Using Brain BioAmp Band	67
5.6.1	Assembly	67
5.6.2	Skin Preparation	67
5.6.3	Measure 1-channel EEG	67

DIY NEUROSCIENCE KIT PRO

This is the advanced DIY Neuroscience Kit with Muscle BioAmp Shield - an EMG Shield for Arduino UNO! The shield offers multiple plug-and-play options, and additional data acquisition while the BioAmp EXG Pill enhances versatility by enabling the measurement of various biopotential signals, including EEG (brain), EOG (eyes), EMG (muscles), and ECG (heart). Start your journey of discovery, as you build exciting projects, develop HCI/BCI applications, and gain valuable insights.

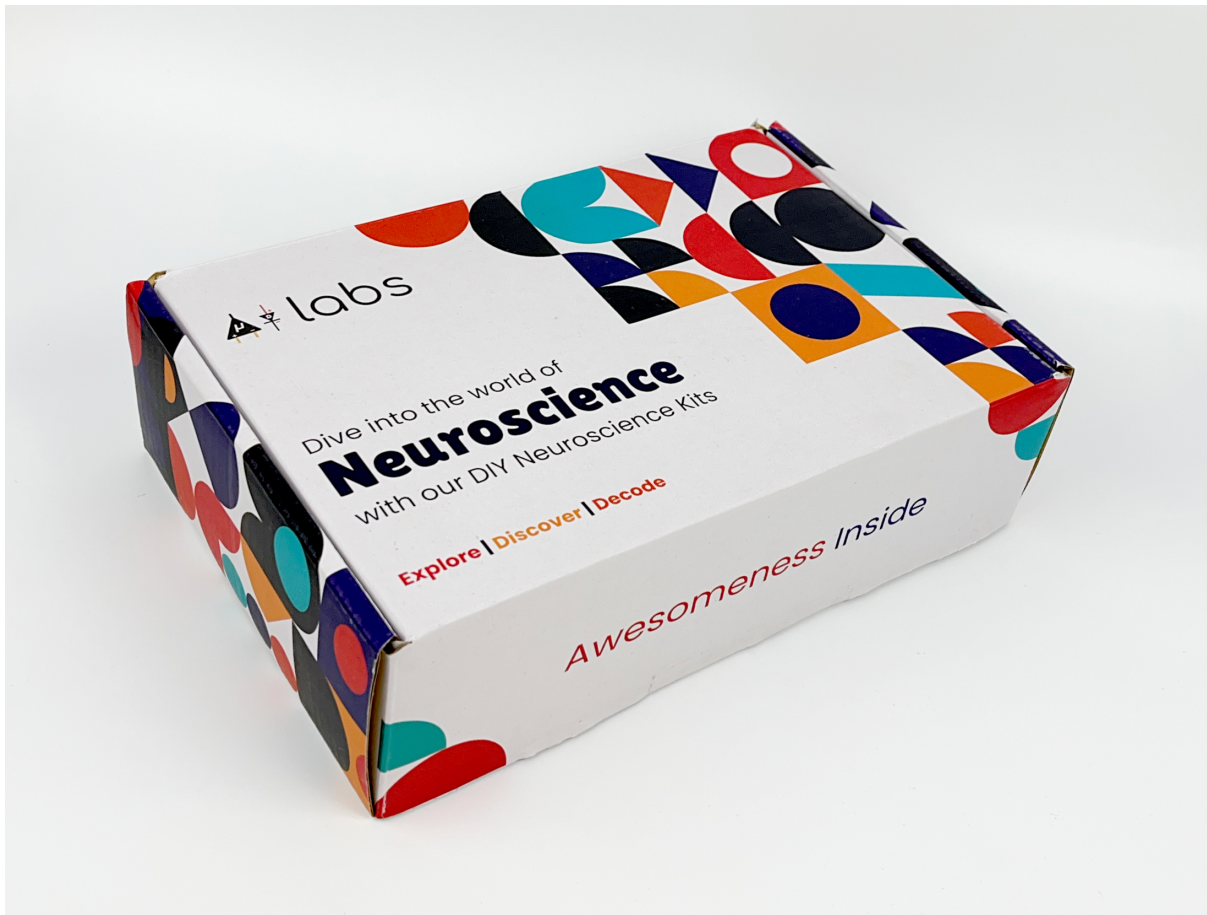
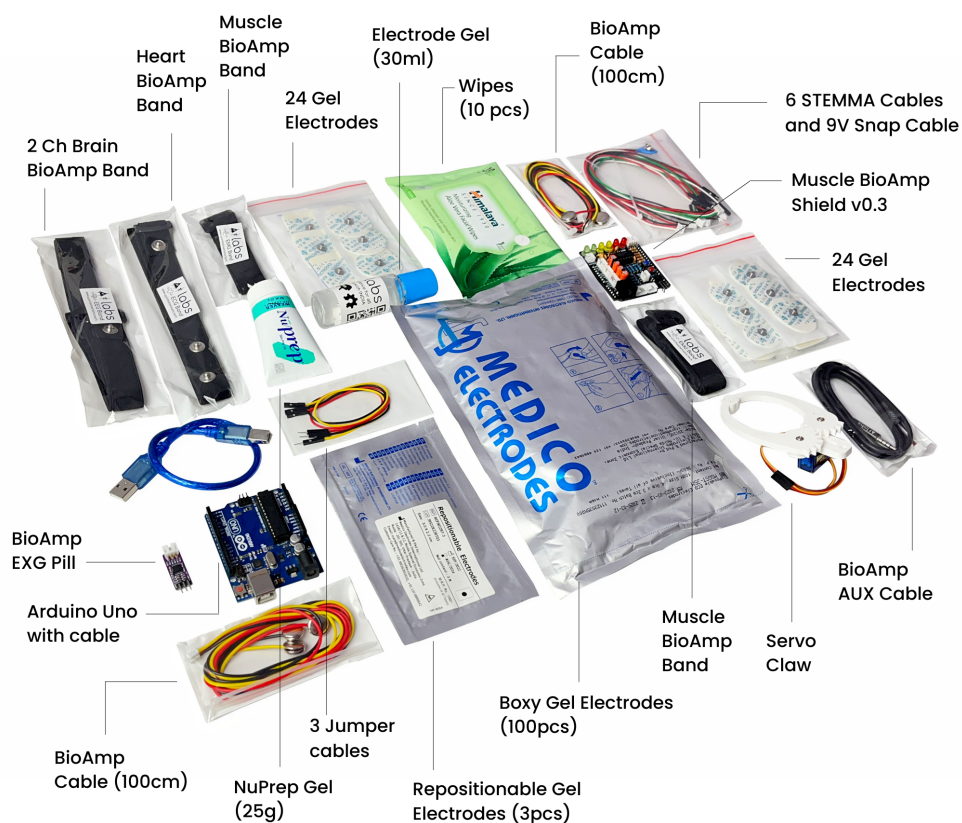

Fig. 1: DIY Neuroscience Kit Pro

1.1 Contents of the kit

Kit Contents	Qty
BioAmp EXG Pill	1
BioAmp Bands	3
BioAmp Cable	1
Jumper Cables (set of 3)	1
Skin Preparation Kit	1
Electrode Gel	1
Gel Electrodes	24+100
Repositionable gel electrodes (3 pc)	1
Arduino UNO R3	1
Servo Claw	1
Muscle BioAmp Shield Kit (With 1 BioAmp Cable, 6 STEMMA Cables, 9V snap cable, BioAmp AUX Cable, Muscle BioAmp Band, 24 gel electrodes, & Muscle BioAmp Shield)	1



DIY Neuroscience Kit – Pro

Click on the link below to see the unboxing of the kit:

<https://youtu.be/Sn389Q7Izy4>

1.2 Software requirements

Download the following according to the operating system you are using (Windows, OSX, Linux):

- Visual Studio Code
- Python
- Spike Recorder
- Arduino IDE v1.8.19 (legacy IDE)

Legacy IDE (1.8.X)

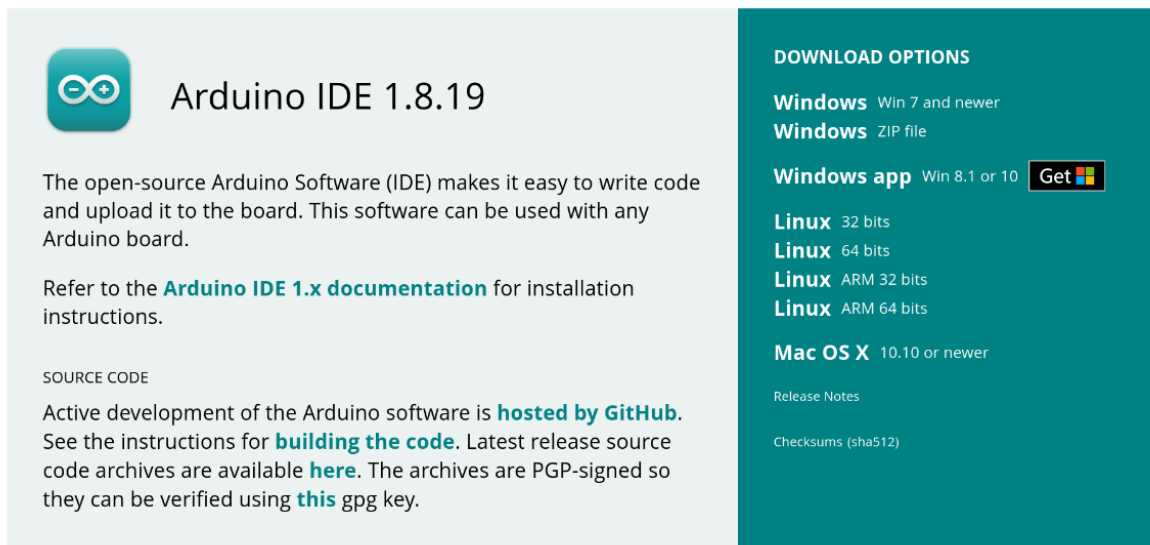

 **Arduino IDE 1.8.19**

The open-source Arduino Software (IDE) makes it easy to write code and upload it to the board. This software can be used with any Arduino board.

Refer to the [Arduino IDE 1.x documentation](#) for installation instructions.

SOURCE CODE

Active development of the Arduino software is [hosted by GitHub](#). See the instructions for [building the code](#). Latest release source code archives are available [here](#). The archives are PGP-signed so they can be verified using [this](#) gpg key.

DOWNLOAD OPTIONS

Windows Win 7 and newer
Windows ZIP file
Windows app Win 8.1 or 10 

Linux 32 bits
Linux 64 bits
Linux ARM 32 bits
Linux ARM 64 bits

Mac OS X 10.10 or newer

[Release Notes](#)
[Checksums \(sha512\)](#)

1.3 Using the kit

DIY Neuroscience Kit Pro includes 2 biopotential sensors:

1. BioAmp EXG Pill (Assembled)
2. Muscle BioAmp Shield v0.3 (Assembled)

You can use these sensors either separately or connect them together to create a 2-channel EXG acquisition system wherein channel 1 can be used to record EMG signals and channel 2 allows you to record all the biopotential signals from your body (EMG, ECG, EOG, EEG).

1.3.1 Step 1: Using BioAmp EXG Pill

BioAmp EXG Pill is a small, powerful analog-front-end (AFE) biopotential signal-acquisition board that can be paired with any microcontroller unit (MCU) or single-board computer (SBC) with an analog-to-digital converter (ADC) such as Arduino UNO & Nano, Adafruit QtPy, STM32 Blue Pill, BeagleBone Black, and Raspberry Pi Pico, to name just a few. It also works with any dedicated ADC, like the Texas Instruments ADS1115 and ADS131M0x, among others.

Note

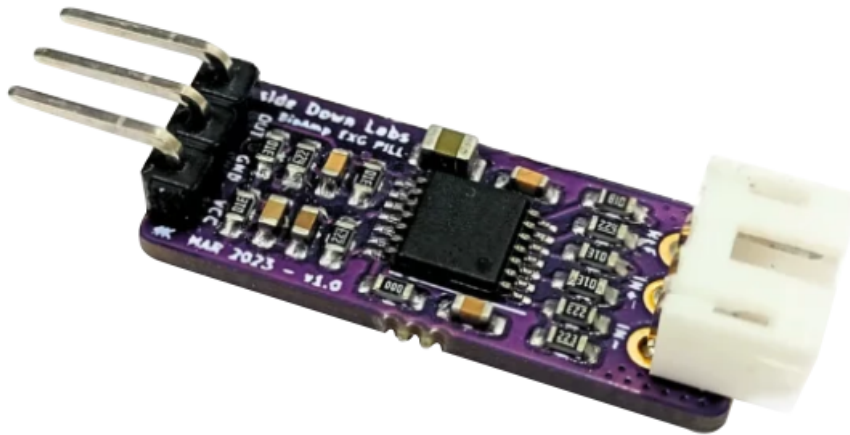

Checkout the complete documentation on [BioAmp EXG Pill](#) which includes how to use the sensor, record various biopotential signals from your body (ECG, EMG, EOG, EEG) and make different HCI/BCI projects using it.

1.3.2 Step 2: Using Muscle BioAmp Shield

Muscle BioAmp Shield is an all-in-one Arduino Uno ElectroMyography (EMG) shield for learning neuroscience with ease which is inspired from BackYard Brains (BYB) [Muscle Spiker Shield](#) and provides similar features like hobby servo output, user buttons, LED Bar, Audio output, and battery input. It is perfect for beginners as they can easily stack it on top of Arduino Uno to record, visualize and listen to their muscle signals to make amazing projects in the domain of Human-Computer Interface (HCI).

Note

Checkout the complete documentation on [Muscle BioAmp Shield](#) which includes how to use the sensor, record/visualise/listen muscle signals and make different HCI projects using it.

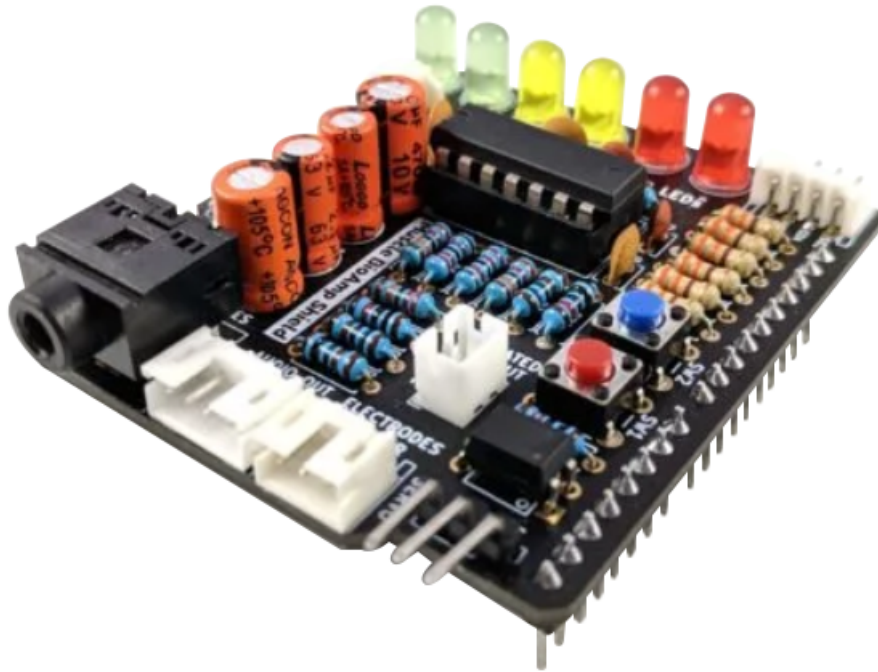

1.3.3 Step 3: Using the sensors together

We believe that you have already gone through the documentation of BioAmp EXG Pill & Muscle BioAmp Shield using the links provided in step 1 and 2 respectively.

You have covered the basic steps till now including connections with the development board, skin preparation, electrodes placements, and recording the signals from your body.

Let's become a PRO and create a 2-channel EXG acquisition system.

a. Connecting Muscle BioAmp Shield to MCU/ADC

Stack the Muscle BioAmp Shield on top of your Arduino Uno properly.

b. Configure for ECG/EMG (optional)

BioAmp EXG Pill is by default configured for recording EEG or EOG but if you want to record good quality ECG or EMG, then it is recommended to configure it by making a solder joint as shown in the image.

Note

Even without making the solder joint the BioAmp EXG Pill is capable of recording ECG or EMG but the signals would be more accurate if you configure it.

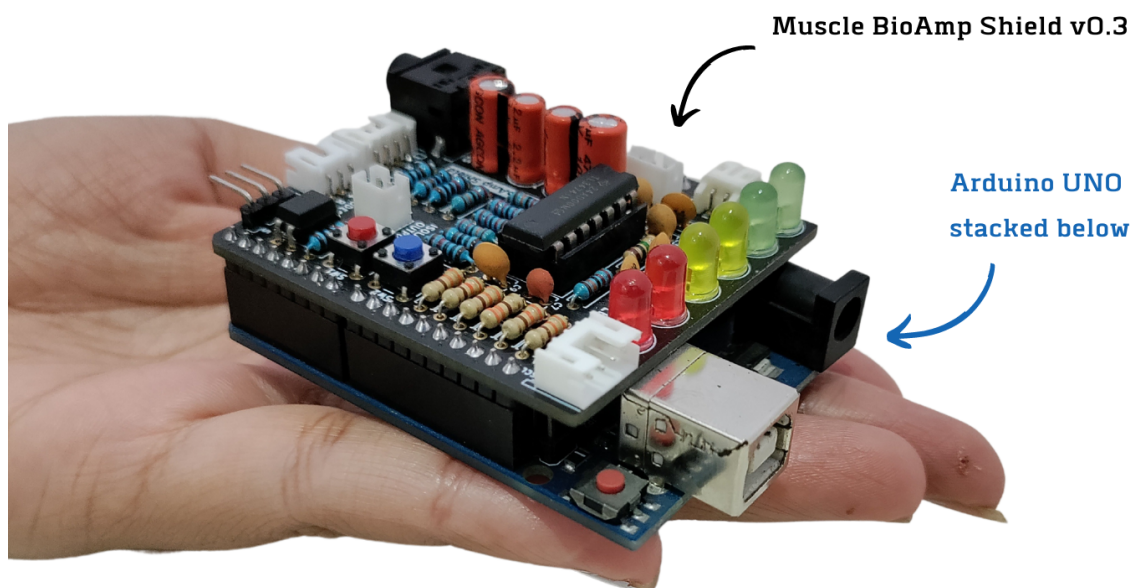

Fig. 2: Stacking Muscle BioAmp Shield on top of Arduino

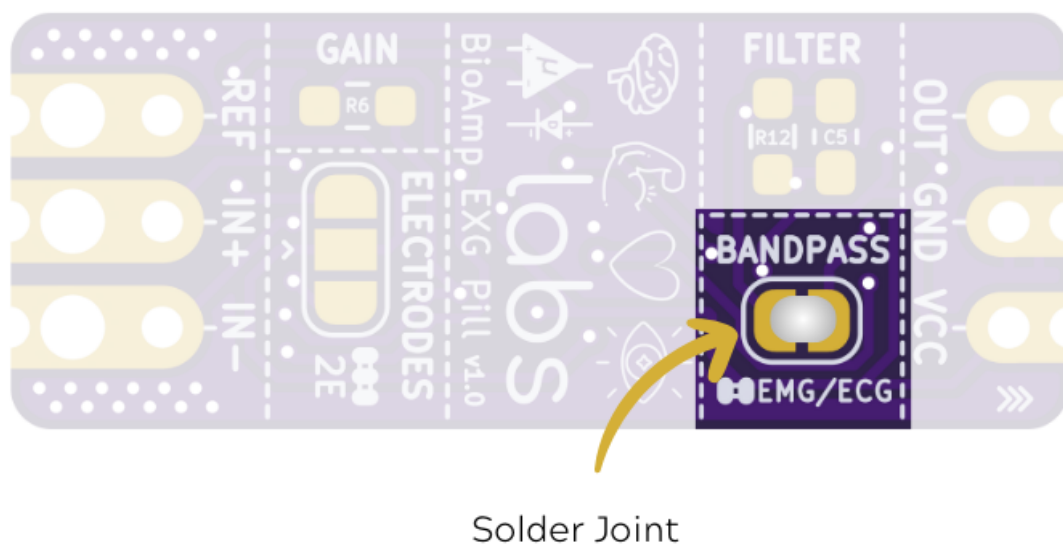

Fig. 3: Configure BioAmp EXG Pill for EMG/ECG

c. Connecting sensors together

Connect the BioAmp EXG Pill to the A2 port of Muscle BioAmp Shield via 3-pin STEMMA cable which has JST PH 2.0mm connector on one end and 3 female jumpers on the other end.

Muscle BioAmp Shield	BioAmp EXG Pill
GND	GND
VCC	5V
A2	OUT

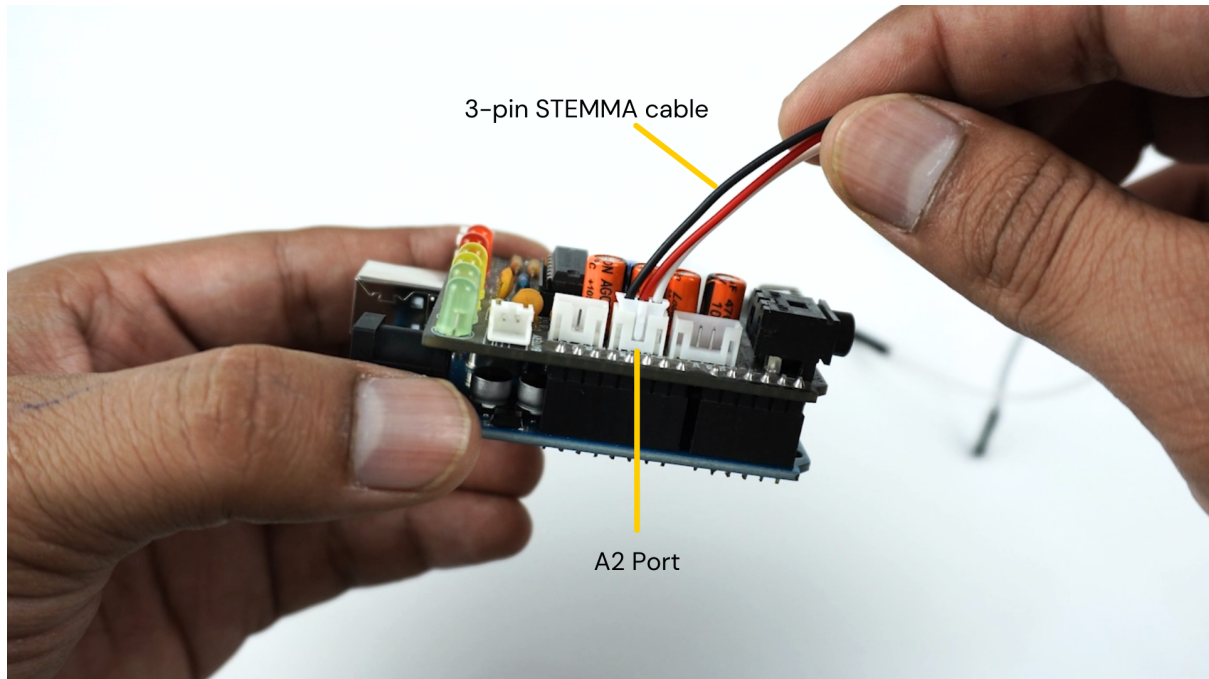

Fig. 4: Inserting JST PH connector in A2 port of Muscle BioAmp Shield

d. Connecting electrode cables

Connect one BioAmp cable to BioAmp EXG Pill and another BioAmp cable to Muscle BioAmp Shield by inserting the cable ends into the respective JST PH connectors as shown below:

e. Skin Preparation

We'll create a 2-channel EMG acquisition system and to do so, we'll be using both the sensors to record EMG signals from the ulnar nerve of both the hands. Thus, prepare the skin accordingly.

Apply Nuprep Skin Preparation Gel on the skin surface where electrodes would be placed to remove dead skin cells and clean the skin from dirt. After rubbing the skin surface thoroughly, clean it with an alcohol wipe or a wet wipe.

For more information, please check out detailed step by step [Skin Preparation Guide](#).

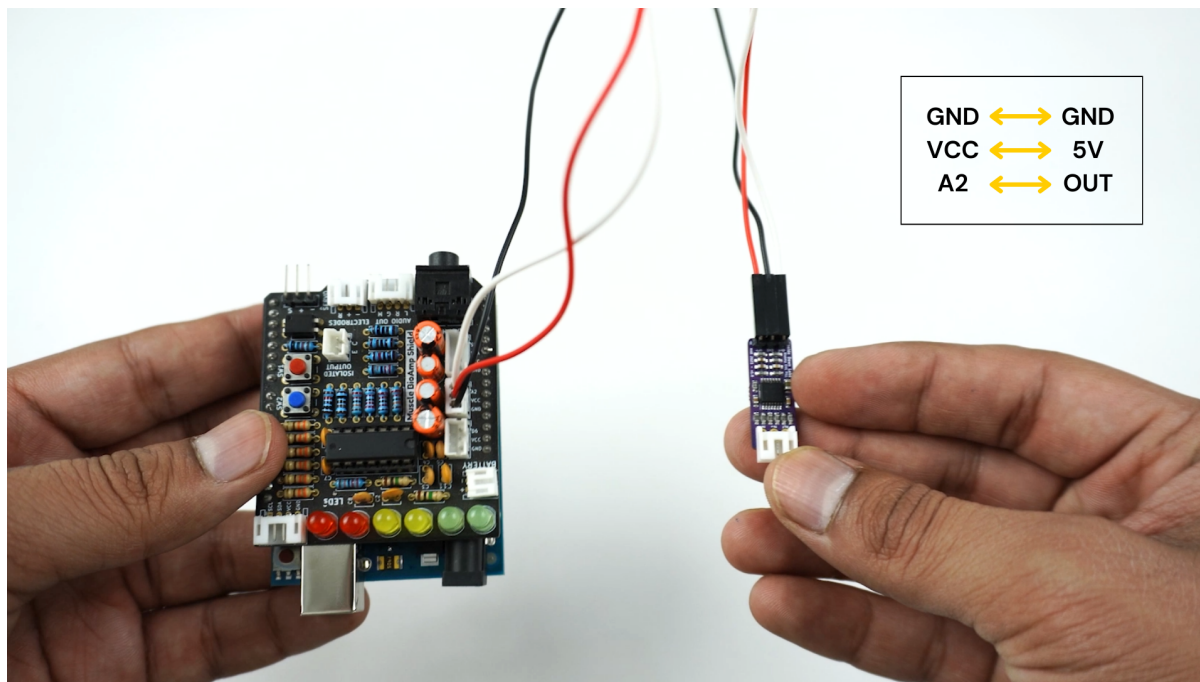

Fig. 5: Muscle BioAmp Shield to BioAmp EXG Pill connections

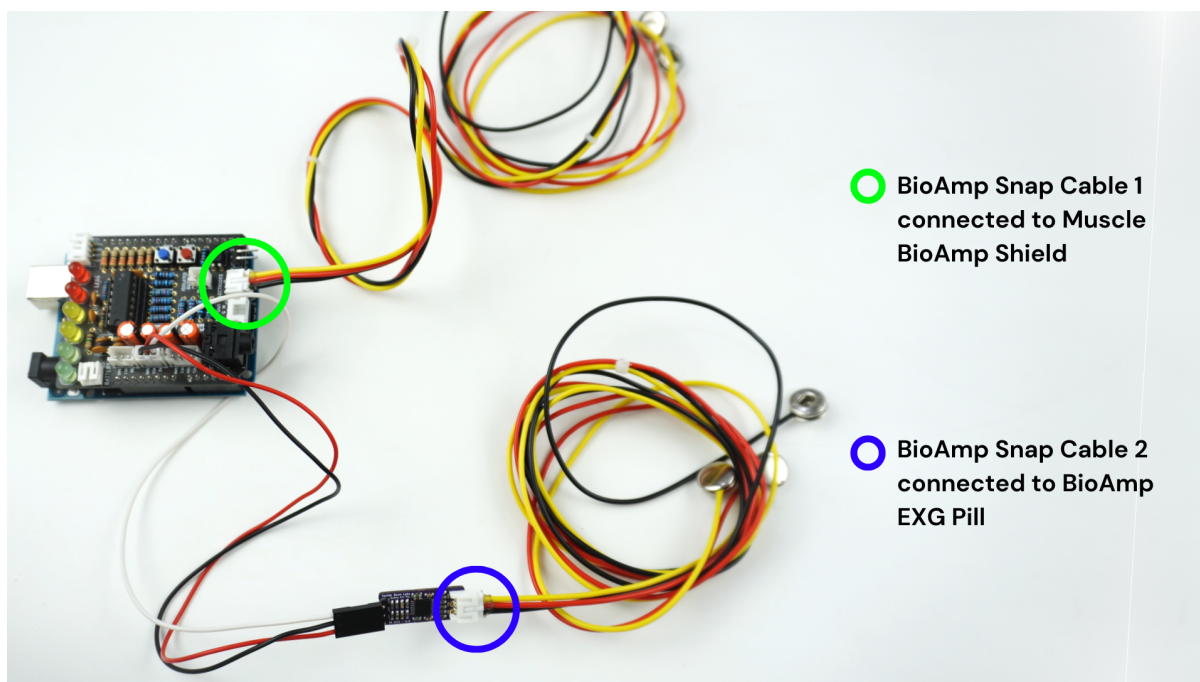

Fig. 6: Connecting BioAmp Cables to the sensors

f. Electrodes placement

We have 2 options to measure the EMG signals, either using the gel electrodes or using dry electrode based Muscle BioAmp Band. You can try both of them one by one.

Using gel electrodes

1. Snap the BioAmp Cable connected to BioAmp EXG Pill to gel electrodes.
2. Peel the plastic backing from electrodes.
3. Place the IN+ and IN- cables on the left arm near the ulnar nerve & REF (reference) at the back of your left hand as shown below.
4. Now snap the BioAmp Cable connected to Muscle BioAmp Shield to gel electrodes.
5. Peel the plastic backing from electrodes.
6. Place the IN+ and IN- cables on the right arm near the ulnar nerve & REF (reference) at the back of your right hand as shown below.

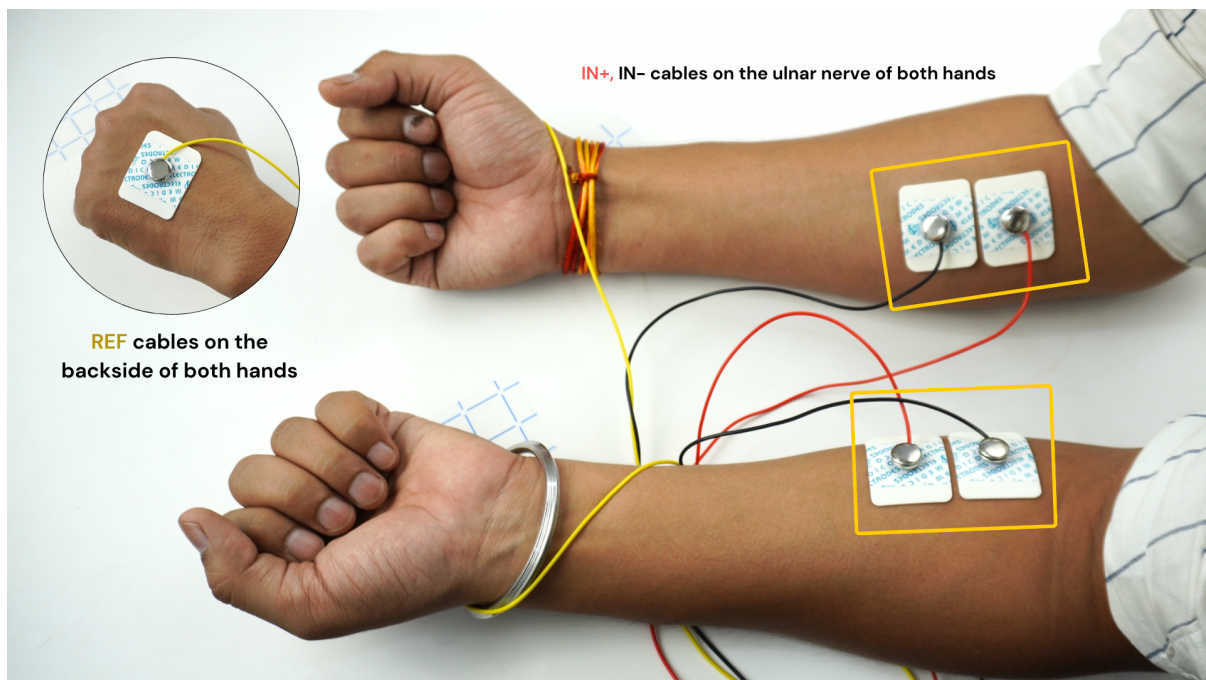

Fig. 7: Gel electrodes placement

Using Muscle BioAmp Band

1. Snap the BioAmp Cable connected to BioAmp EXG Pill on Muscle BioAmp Band in a way such that IN+ and IN- are placed on the left arm near the ulnar nerve & REF (reference) on the far side of the band.
2. Snap the BioAmp Cable connected to Muscle BioAmp Shield on Muscle BioAmp Band in a way such that IN+ and IN- are placed on the right arm near the ulnar nerve & REF (reference) on the far side of the band.
3. Now put a small drop of electrode gel between the skin and metallic parts of BioAmp Cables to get the best results.

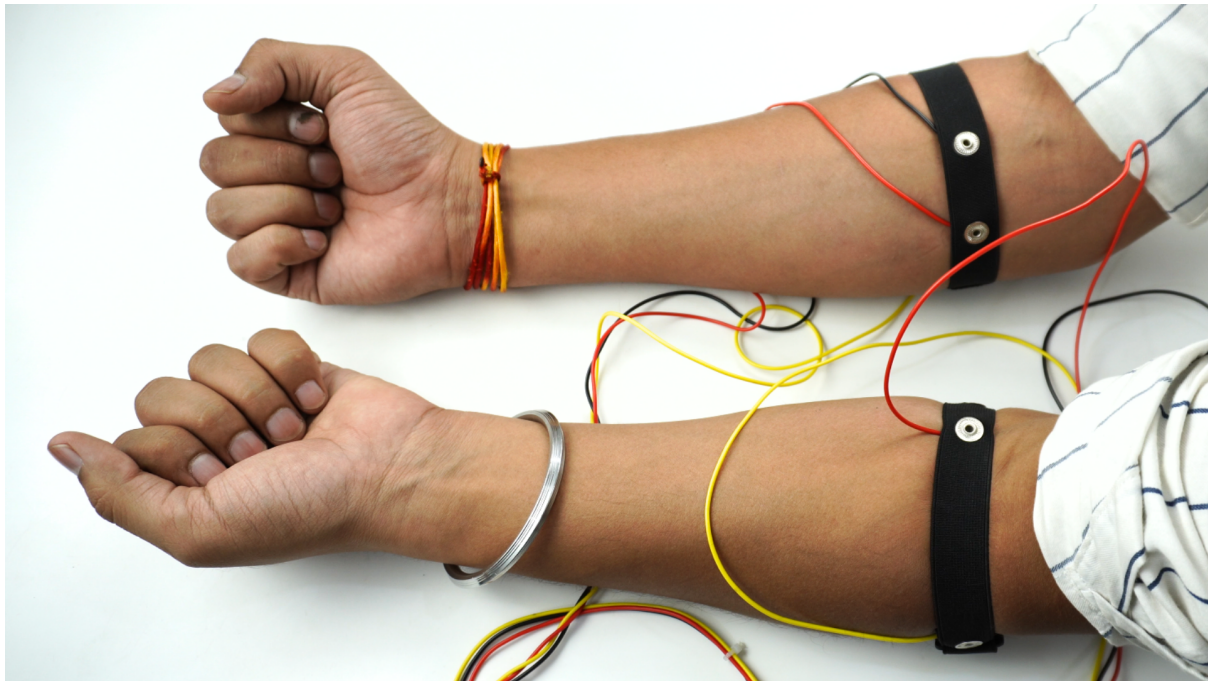

Fig. 8: Muscle BioAmp Band placement

Tip

Visit the complete documentation on how to *assemble and use the BioAmp Bands* or follow the youtube video given below.

Tutorial on how to use the band:

<https://youtu.be/xYZdw0aesa0>

Note

In this demonstration we are recording EMG signals from the ulnar nerve, but you can record EMG from other areas as well (biceps, triceps, legs, jaw etc) as per your project requirements. Just make sure to place the IN+, IN- electrodes on the targeted muscle and REF on a bony part.

g. Uploading the code

Connect Arduino Uno to your laptop using the USB cable (Type A to Type B). Download the github repository given below:

Muscle BioAmp Arduino Firmware

Go to the folder `8_EMGScrolling`, open the arduino sketch `8_EMGScrolling.ino` in Arduino IDE.

Go to `tools` from the menu bar, select board option then select Arduino UNO. In the same menu, select the COM port on which your Arduino Uno is connected. To find out the right COM port, disconnect your Arduino UNO board and reopen the menu. The entry that disappears should be the right COM port. Now upload the code.

Important

Make sure your laptop is not connected to a charger and sit 5m away from any AC appliances for best signal acquisition.

h. Testing the connections

Go to **tools** from the menu bar, click on **serial monitor** to open it or click on the icon on the top right corner. Try flexing both of your arms one-by-one. The output values should be 0 at this point.

Press the **SW1** button on Muscle BioAmp Shield. Now you'll see green LED glowing on the LED bar. When you flex your right arm, you'll get output value 1 on the serial monitor and red LED will glow. Similarly, when you flex your left arm, you'll get output value 2 and yellow LED will glow.

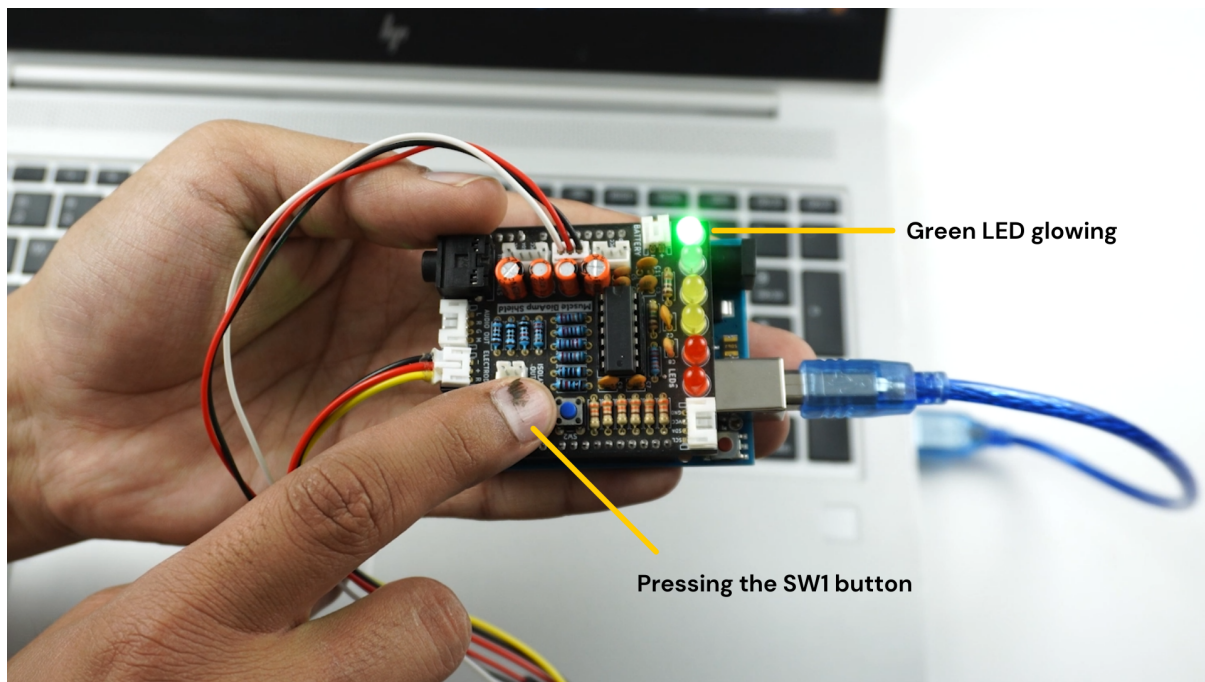

Fig. 9: Press the SW1 button to start getting the output

i. Running python script

Open Visual Studio Code, click on **File > Open folder** to open the folder **8_EMGScrolling**.

Open the terminal, and ensure that the path is configured to the location of the **requirements.txt** file.

To install all the modules that are required to run the Python script, write the given command in the terminal:

```
pip install -r requirements.txt
```

Open **EMG_Scroll.py** and change the COM Port in the code (line 14) as per the COM Port you selected in Arduino IDE. Save the file by clicking **CTRL + S**.

```
# Arduino serial port interface
ser = serial.Serial('COM12', 115200, timeout=1)
```

Run the Python script **EMG_Scroll.py** by writing the given command in the terminal:

```
python EMG_Scroll.py
```

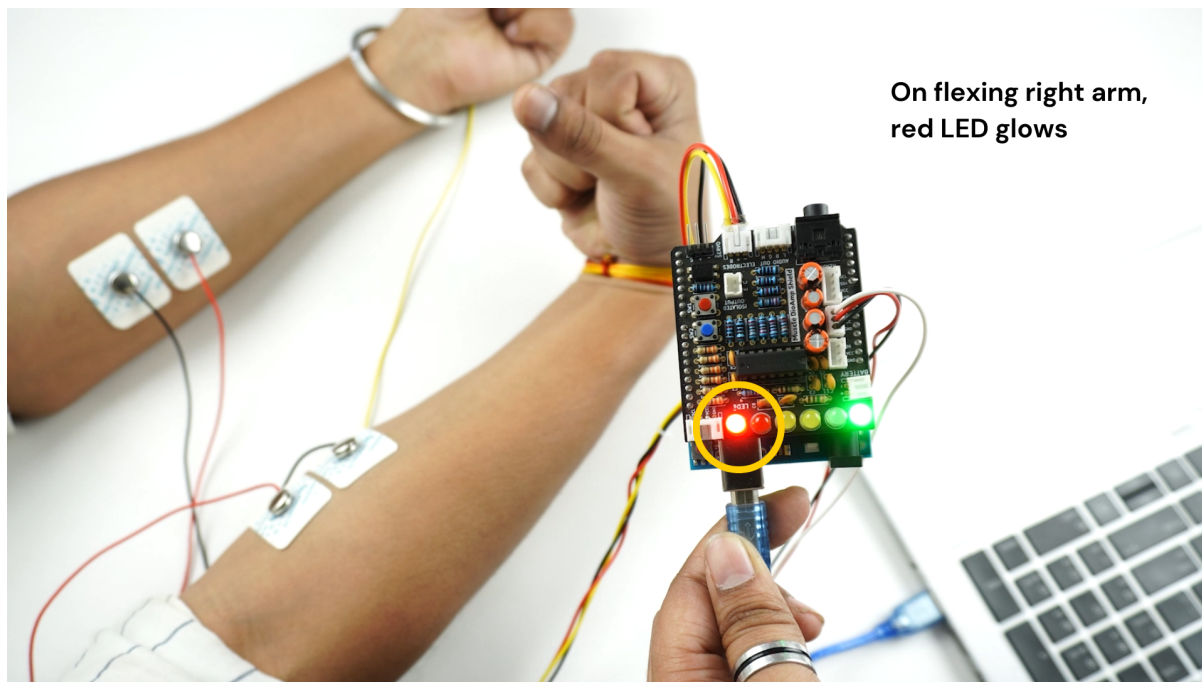

On flexing right arm,
red LED glows

Fig. 10: Flex the right arm, red LED glows

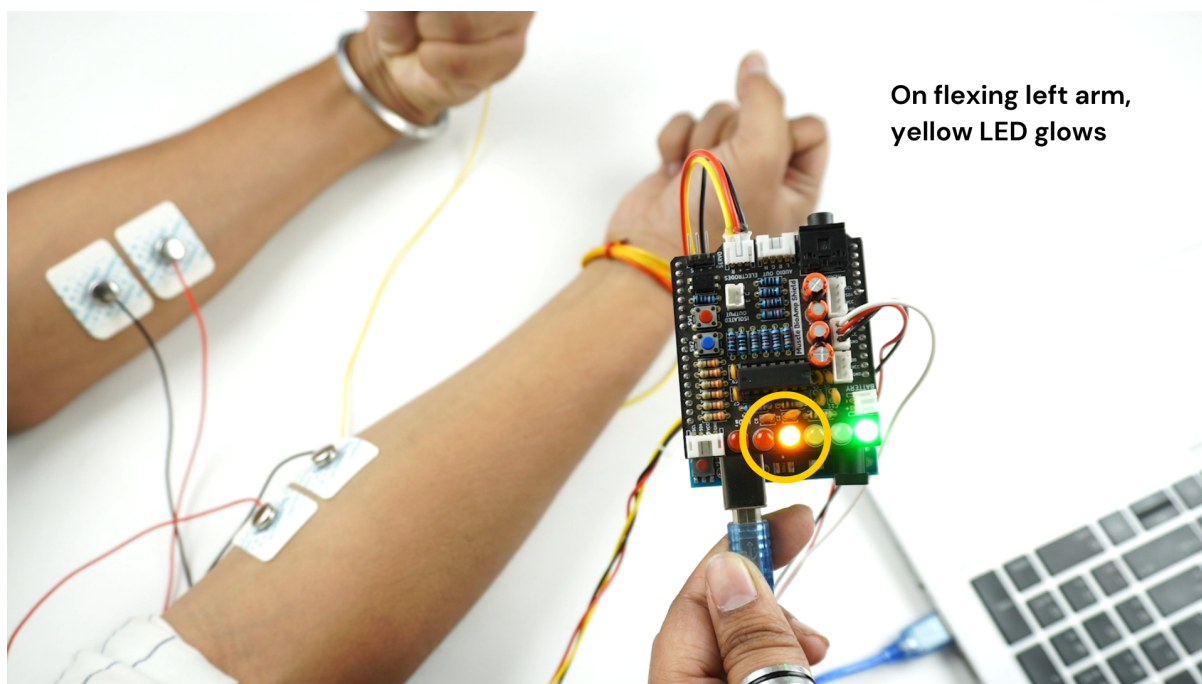

On flexing left arm,
yellow LED glows

Fig. 11: Flex the left arm, yellow LED glows

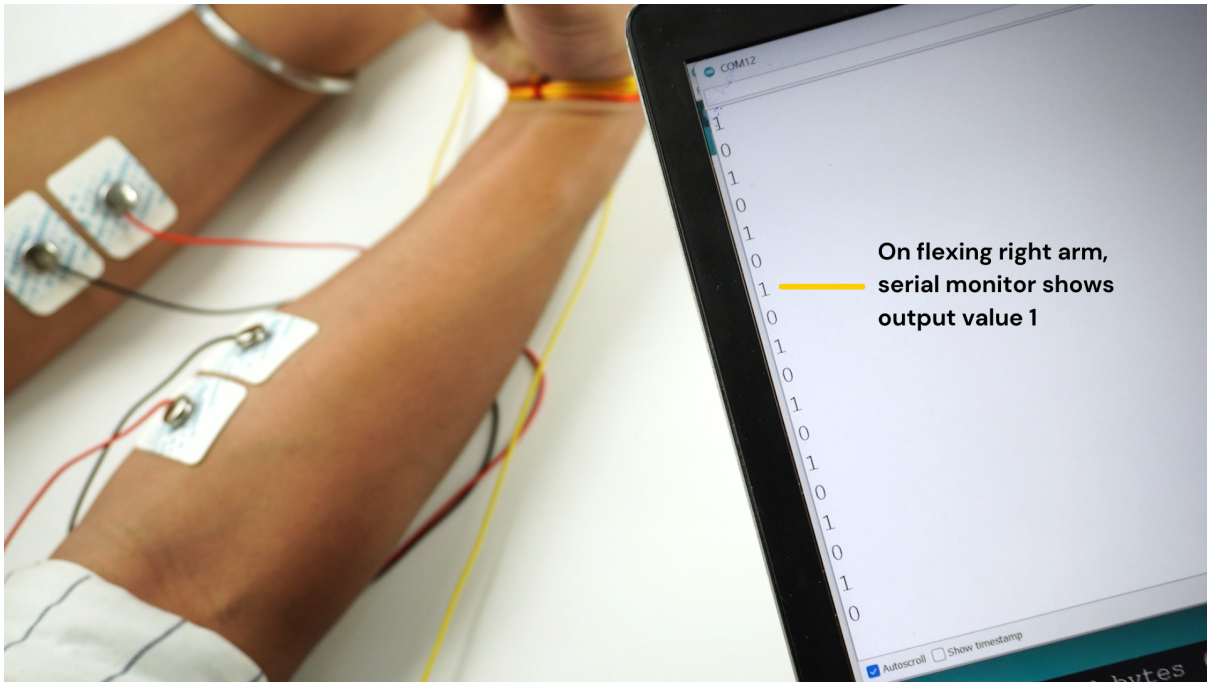

Fig. 12: Flex the right arm, serial monitor shows output value 1

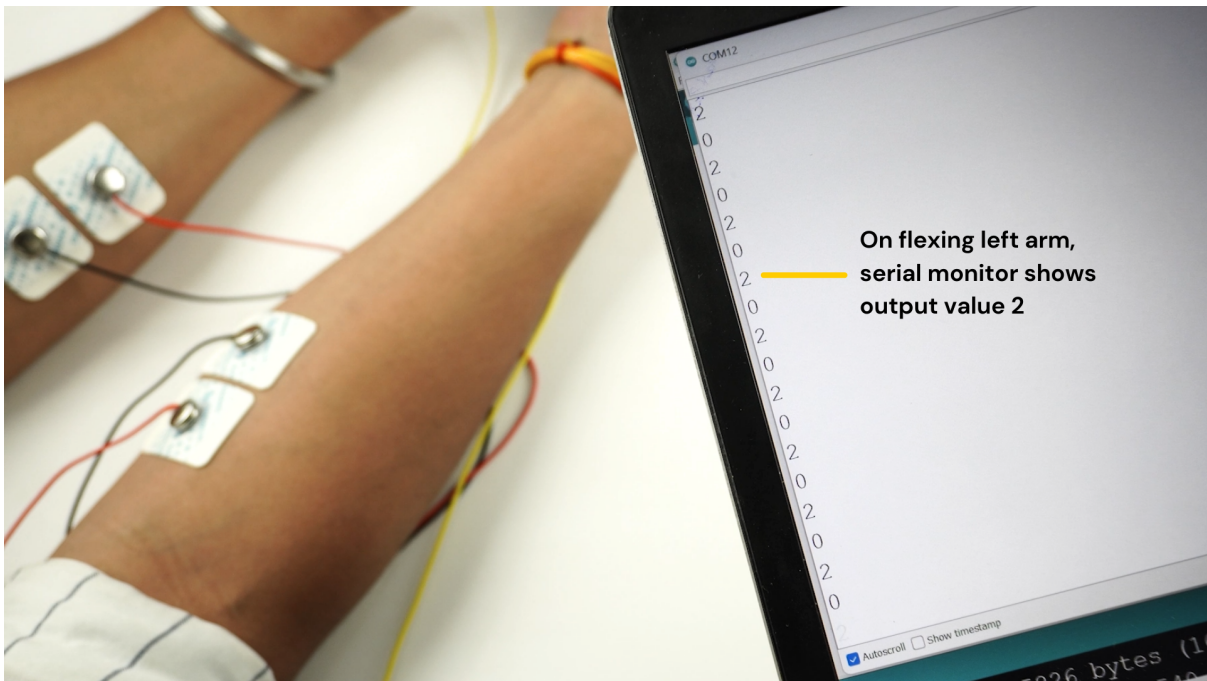
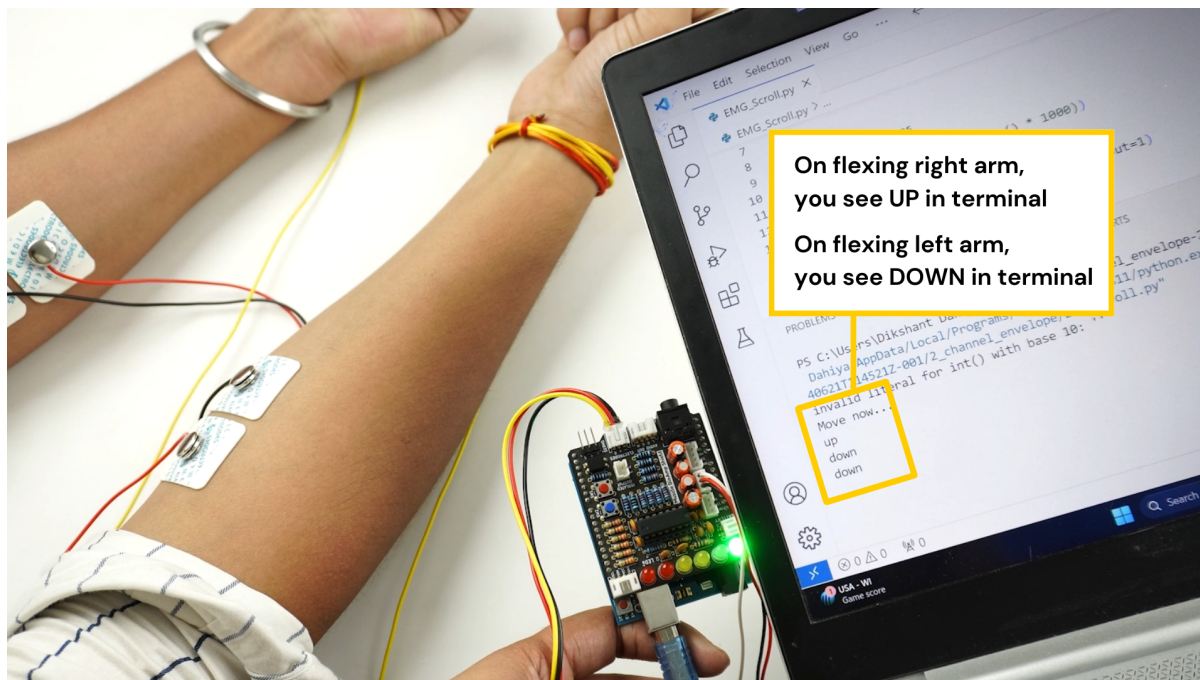

Fig. 13: Flex the left arm, serial monitor shows output value 2

j. Scrolling using EMG signals

Press the SW1 button on Muscle BioAmp Shield again.

In the terminal, you will see Move Now prompt. When you flex your right arm, you'll see UP in the terminal. Similarly, when you move your left arm, you'll see DOWN in the terminal.



Now, open youtube shorts on your laptop and start scrolling using your muscle signals.

Note

What's happening in the background? Whenever an EMG signal is detected, it acts as a trigger to emulate UP or DOWN key on the keyboard.

k. Calibrating the code

Changes in Arduino Sketch

Modify the threshold values on **lines 73 and 74**. Threshold 1 is for the EMG signals recorded from the Muscle BioAmp Shield, and threshold 2 is for the EMG signals recorded from the BioAmp EXG Pill.

Uncomment line 71 in the Arduino code and navigate to Tools > Serial Plotter. You'll see two plots showing the EMG signals of both of your arms. Flex your right arm and observe the peak value on the y-axis. If the peak value is around 240, you can set threshold 1 anywhere between 150 to 200. The lower the threshold value, the easier it is to trigger the output as UP or DOWN, and vice versa. Repeat the process to determine the threshold 2 value for your left arm.

After setting the thresholds, comment out line 71.

Changes in Python script

Adjust the latency value on **line 51**. A higher latency value will make the output less responsive, requiring you to flex and hold longer to scroll through the screen. A lower latency value will make the output more responsive, allowing you to scroll through the screen more easily.

I. Conclusion

This was just a demonstration to show you how both the sensors (BioAmp EXG Pill & Muscle BioAmp Shield) can be used together to create a 2-channel EXG acquisition system. In this project, we used BioAmp EXG Pill to record EMG signals, but it can also be used to record other biopotential signals as well like ECG, EOG, or EEG.

1.4 Some project ideas

You can find step-by-step tutorials for various HCI/BCI projects on our [Instructables](#).

1.4.1 Projects made using BioAmp EXG Pill

1. Controlling video game using brainwaves (EEG)
2. Visualising electrical impulses from eyes (EOG)
3. Recording EEG from visual cortex part of brain
4. Recording EEG from prefrontal cortex part of brain
5. Eye blink detection
6. Creating a drowsiness detector
7. Record publication-grade ECG
8. Measuring heart rate
9. Detecting heart beats
10. Record publication-grade EMG
11. Detecting up and down movement of eyes

1.4.2 Projects made using Muscle BioAmp Shield

1. Record, visualise, and listen to EMG signals
2. Controlling 3d-printed servo claw using EMG
3. Controlling prosthetic hand using EMG
4. Building the ultimate servo claw game
5. Building muscle strength game

1.4.3 Projects made using the sensors together

1. Control dino game using eye blinks
2. Control servo claw using EOG

These are some of the project ideas but the possibilities are endless. So create your own Human Computer Interface (HCI) and Brain Computer Interface (BCI) projects and share them with us at contact@upsidedownlabs.tech

BIOAMP EXG PILL

v1.0

2.1 Overview

BioAmp EXG Pill is a small, powerful analog-front-end (AFE) biopotential signal-acquisition board that can be paired with any microcontroller unit (MCU) or single-board computer (SBC) with an analog-to-digital converter (ADC) such as Arduino UNO & Nano, Adafruit QtPy, STM32 Blue Pill, BeagleBone Black, and Raspberry Pi Pico, to name just a few. It also works with any dedicated ADC, like the Texas Instruments ADS1115 and ADS131M0x, among others.

Note

It is recommended to use Arduino UNO R4 while recording biopotential signals since it has 14-bit ADC and can record the signals much accurately.

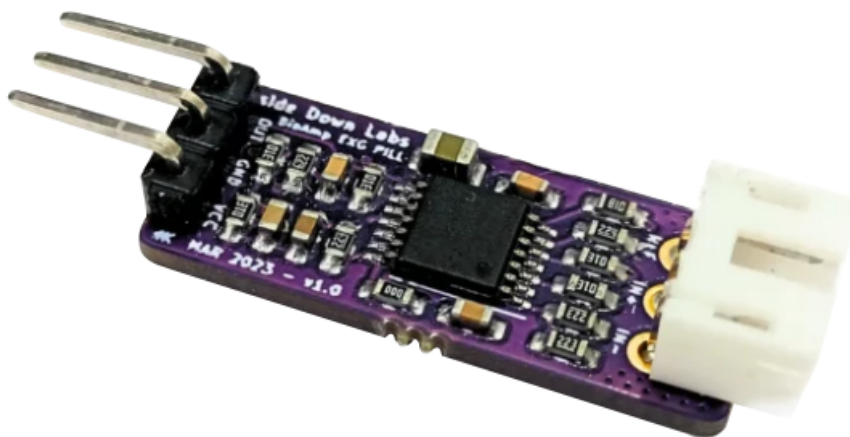

2.2 What makes it different?

1. Record publication-quality biopotential signals like ECG, EMG, EOG, or EEG.
2. Small size (25.4 x 10.0mm) allows easy integration into mobile and space-constrained projects.
3. Powerful noise rejection makes it usable even when the device is close to the AC mains supply.
4. Any 1.5 mm diameter wire can be used as a strain-relieving electrode cable, making it very cost-effective.
5. Pair it with any MCU with an ADC. It is by default compatible with 5V but you can make it compatible with 3.3V as well using a voltage divider.
6. Configure the gain, band pass filter and electrode count according to your requirements.

2.3 Features & Specifications

Operating Voltage	5 V
Input Impedance	10^{12} ohm
Compatible Hardware	Any development board with an ADC (Arduino UNO & Nano, Adafruit QtPy, STM32 Blue Pill, BeagleBone Black, Raspberry Pi Pico, to name just a few) or any standalone ADC of your choice
BioPotentials	EMG, ECG, EOG, EEG (configurable band-pass, by default configured for EEG & EOG)
No. of channels	1
Electrodes	2 or 3 (By default configured for 3 electrodes)
Dimensions	25.4 x 10 mm
Open Source	Hardware + Software

2.4 Board layout

BioAmp EXG Pill's elegant design allows it to be used in 3 ways:

1. Pin-header holes allow you to solder (berg strip) pin headers for easy use with a breadboard.
2. Castellated holes allow you to solder BioAmp EXG Pill directly onto a custom PCB that requires biopotential-amplification capabilities.
3. Electrode holes allow you to use any 1.5 mm diameter wire as an electrode cable with minimal strain.

2.4.1 BioAmp EXG Pill is fully configurable

1. Increase the gain of the instrumentation amplifier by using a 0603 resistor at R6. Decrease gain and configure the bandpass filter by using 0603 parts at R12 and C5. Band limiting is very useful for EOG and EEG recording. Also, the signal sometimes clips while recording an ECG with electrodes very close to the heart. Creating a solder jumper for a band-pass filter helps with that. By default, BioAmp EXG Pill is configured to record EEG and EOG but you can bridge the pads (below bandpass) with solder to make it configurable for EMG and ECG.
2. The normal method of operation for best-quality signal amplification is to use 3 electrodes by default but you can bridge the pads (below electrodes) to make it configurable for 2 electrodes. The 2-electrode mode

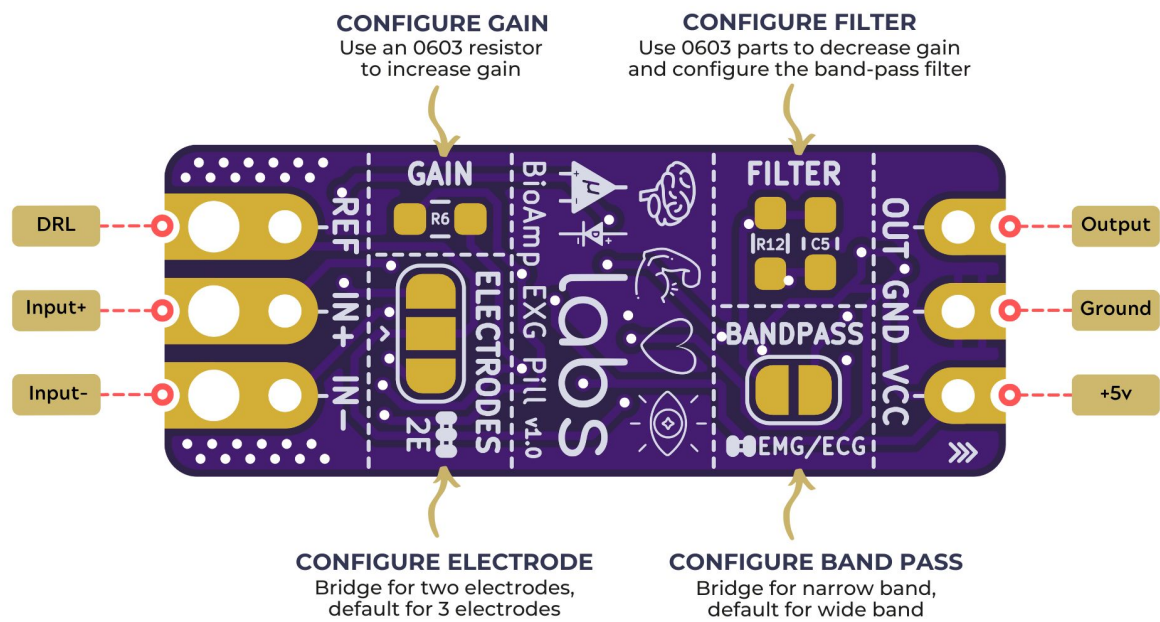
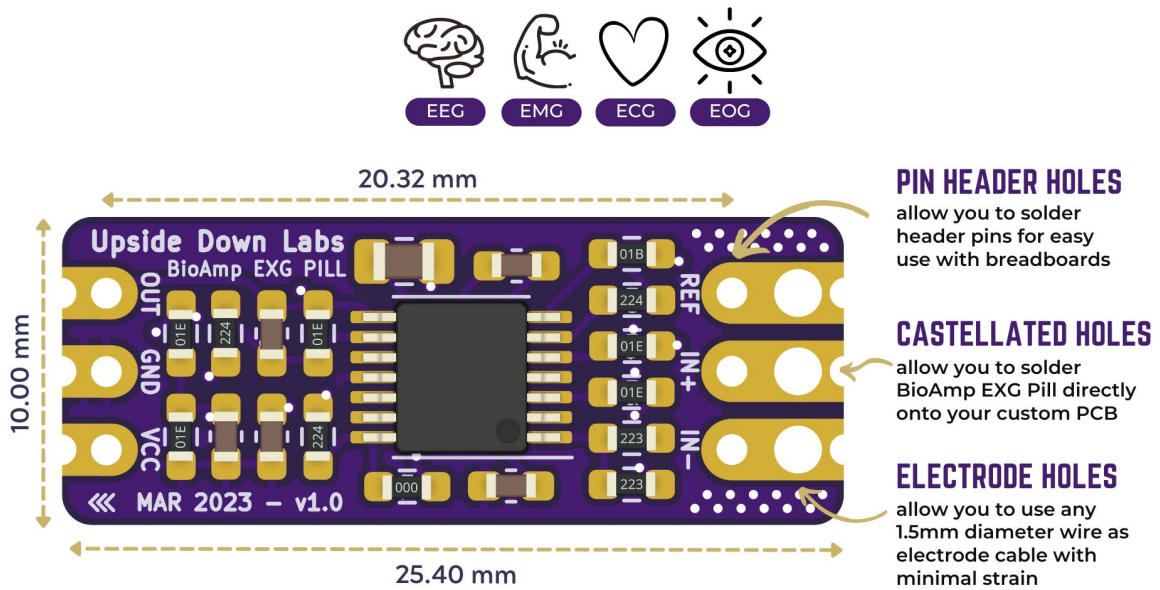

is specifically included for projects like heart (ECG) patches for HRV. It's only supposed to be used with a battery-operated setup and is quite prone to high interference noise due to a lack of proper reference on the body (This option is not recommended for most operations)

2.5 Software requirements

- Before you start using the kit, please download [Arduino IDE v1.8.19 \(legacy IDE\)](#). Using this you'll be able to upload the arduino sketches in your development board and visualise the data on your laptop.

Legacy IDE (1.8.X)



Arduino IDE 1.8.19

The open-source Arduino Software (IDE) makes it easy to write code and upload it to the board. This software can be used with any Arduino board.

Refer to the [Arduino IDE 1.x documentation](#) for installation instructions.

SOURCE CODE

Active development of the Arduino software is [hosted by GitHub](#). See the instructions for [building the code](#). Latest release source code archives are available [here](#). The archives are PGP-signed so they can be verified using [this](#) gpg key.

DOWNLOAD OPTIONS

Windows Win 7 and newer
Windows ZIP file

Windows app Win 8.1 or 10 [Get](#) 

Linux 32 bits
Linux 64 bits
Linux ARM 32 bits
Linux ARM 64 bits

Mac OS X 10.10 or newer

[Release Notes](#)

[Checksums \(sha512\)](#)

- Download Backyard Brains' [Spike Recorder](#) according to the operating system you are using (Windows, OSX, Linux).



Documents

- [PC Documentation](#)
- [iOS Documentation](#)
- [Tutorial: Using Spike Recorder with](#)

BYB Spike Recorder

Now you can record data straight to your laptop or computer! The BYB Spike Recorder turns your PC into a high-tech data recording and analysis tool.

Recording Spikes

Using our DVR-esque interface, you will never miss a spike! The software is always recording in the background, so you can play back that response you just saw in real-time. Need to save it for later so you can show your friends? You can record the data directly in our app.

Free!

- [Windows](#)
- [OSX](#)
- [Linux](#)
- [Arduino](#)

2.6 Using the Hardware

If you have received the assembled BioAmp EXG Pill then you can skip the step 1 and move on to step 2.

2.6.1 Step 1: Solder Connectors

Insert the provided BioAmp cable's JST PH connector and header pins from top as shown in the image and solder them from below.

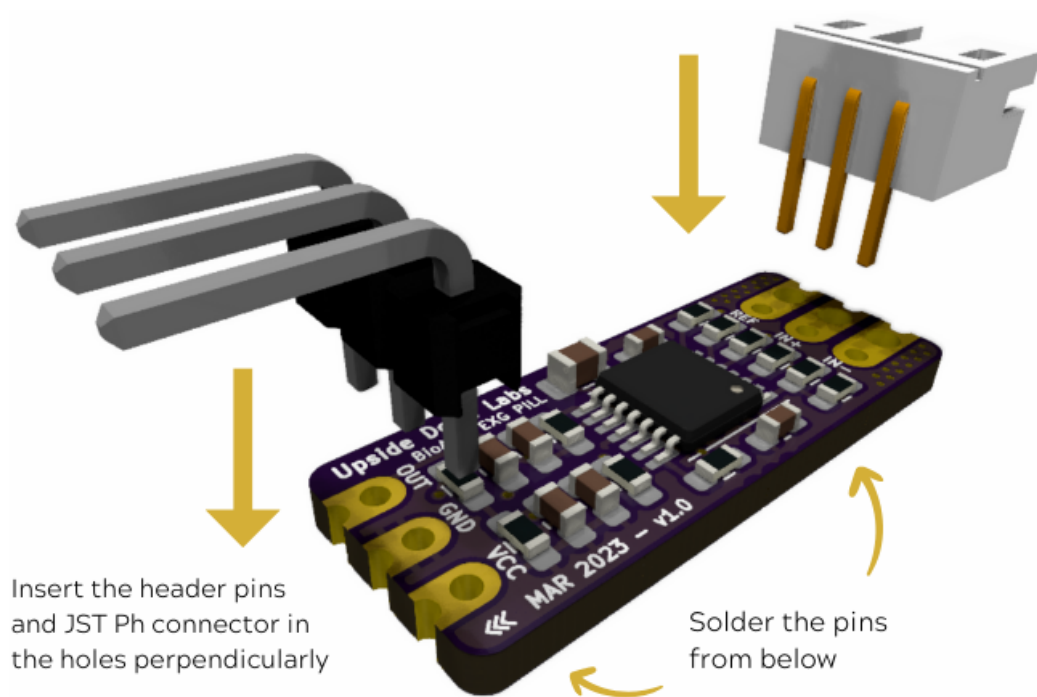

Fig. 1: Soldering the connector & header pins on BioAmp EXG Pill

2.6.2 Step 2 (optional): Configure for ECG/EMG

BioAmp EXG Pill is by default configured for recording EEG or EOG but if you want to record good quality ECG or EMG, then it is recommended to configure it by making a solder joint as shown in the image.

Note

Even without making the solder joint the BioAmp EXG Pill is capable of recording ECG or EMG but the signals would be more accurate if you configure it.

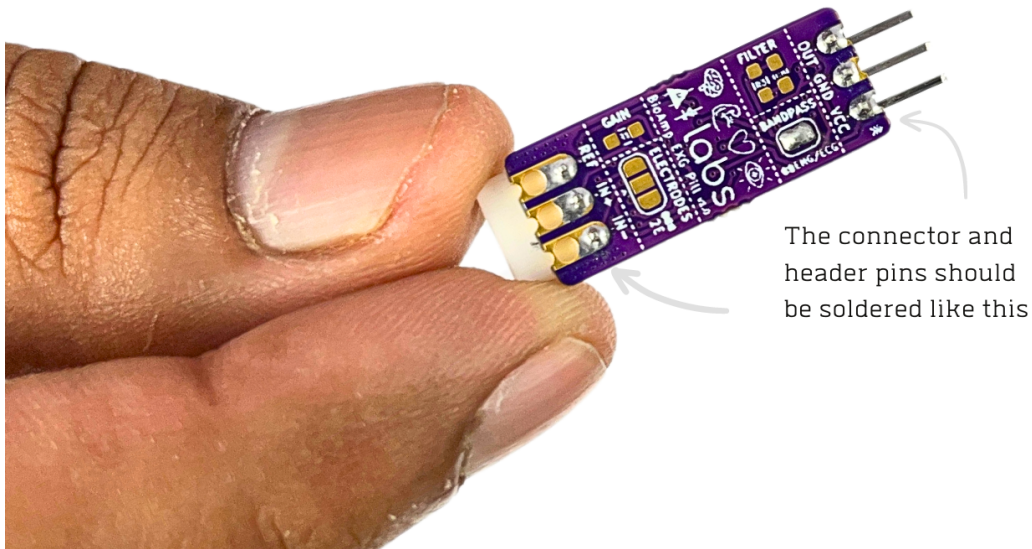
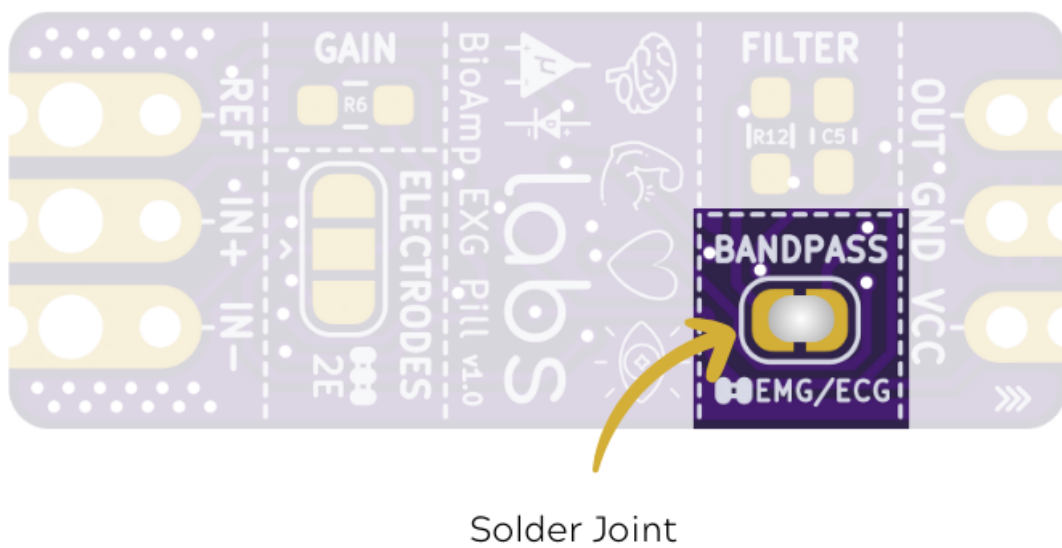

Fig. 2: After soldering, BioAmp EXG Pill should look like this



2.6.3 Step 3: Connect MCU/ADC

Connect your BioAmp EXG Pill to your MCU/ADC as per the connection table shown below:

Table 1: BioAmp to MCU/ADC connection

BioAmp	MCU/ADC
VCC	5V
GND	GND
OUT	ADC Input

For all the examples provided, we are using the A0 pin of Arduino UNO R3. Connect your BioAmp to your MCU/ADC via jumper cables provided in the kit. If you are connecting OUT pin of BioAmp to any other analog pin (A0-A5) of Arduino UNO board, then you will have to change the INPUT PIN in the Arduino sketch accordingly.

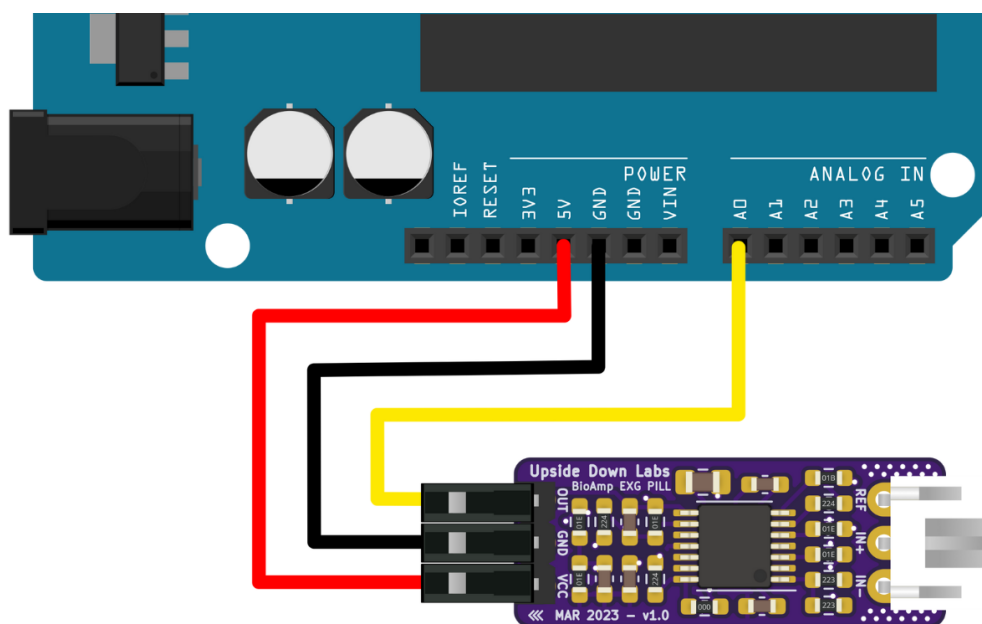

Fig. 3: Connections with Arduino UNO R3

Warning

Take precautions while connecting to power, if power pins are to be swapped, your BioAmp EXG Pill will be fried and it'll become unusable (DIE).

2.6.4 Step 4: Connecting electrode cable

Connect the BioAmp cable to BioAmp EXG Pill by inserting the cable end in the JST PH connector as shown in the graphic below.

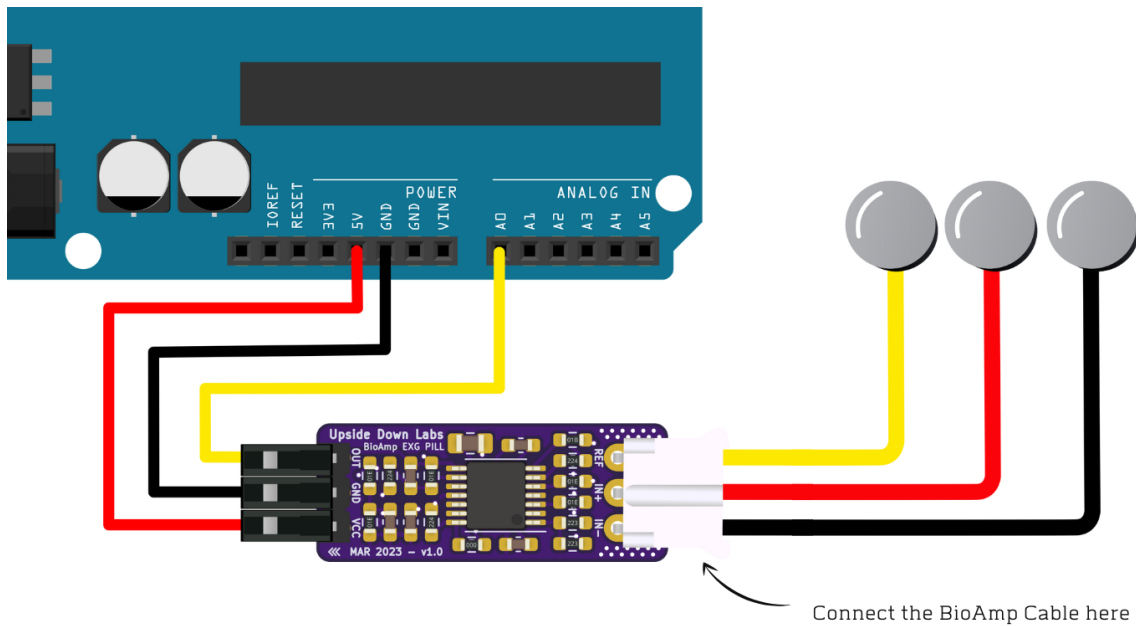

Fig. 4: Connections with BioAmp Cable v3

2.6.5 Step 5: Skin Preparation

Apply Nuprep Skin Preparation Gel on the skin surface where electrodes would be placed to remove dead skin cells and clean the skin from dirt. After rubbing the skin surface thoroughly, clean it with an alcohol wipe or a wet wipe.

For more information, please check out detailed step by step *Skin Preparation Guide*.

2.6.6 Step 6: Measuring ElectroMyoGraphy (EMG)

Note

Electromyography (EMG) is a technique for evaluating and recording the electrical activity produced by skeletal muscles. EMG is also used as a diagnostic procedure to assess the health of muscles and the nerve cells that control them (motor neurons). EMG results can reveal nerve dysfunction, muscle dysfunction, or problems with nerve-to-muscle signal transmission.

Electrodes placement

We have 2 options to measure the EMG signals, either using the gel electrodes or using dry electrode based Muscle BioAmp Band. You can try both of them one by one.

- **Using gel electrodes:**

1. Connect the BioAmp cable to gel electrodes,
2. Peel the plastic backing from electrodes
3. Place the IN+ and IN- cables on the arm near the ulnar nerve & REF (reference) at the back of your hand as shown in the connection diagram.

- **Using Muscle BioAmp Band:**

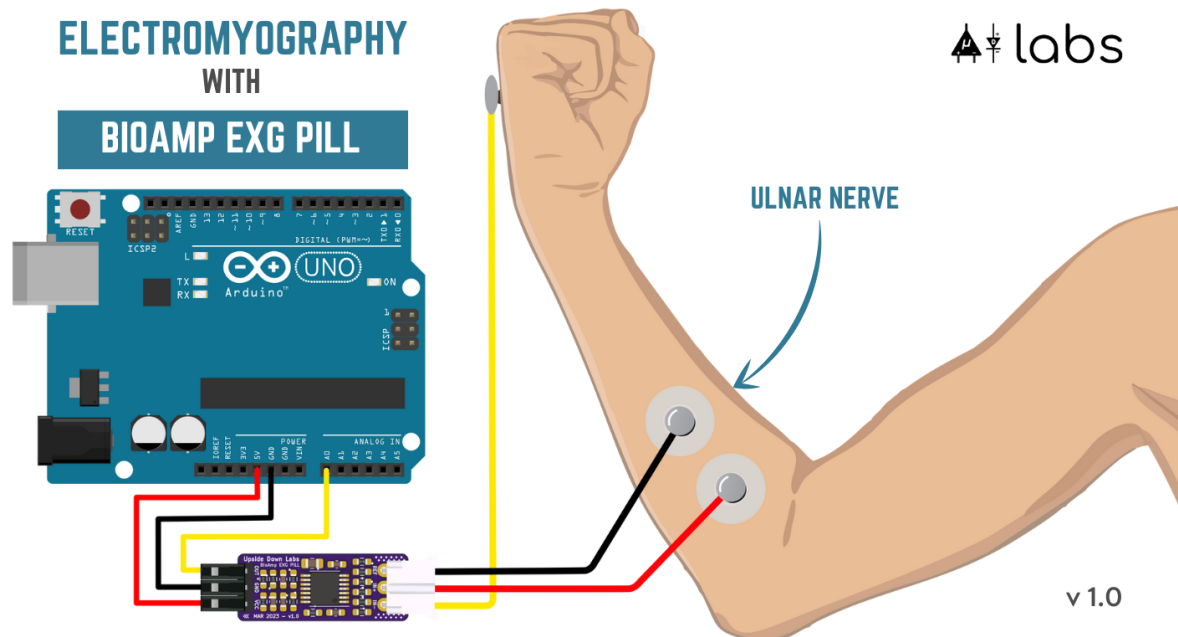

1. Connect the BioAmp cable to Muscle BioAmp Band in a way such that IN+ and IN- are placed on the arm near the ulnar nerve & REF (reference) on the far side of the band.
2. Now put a small drop of electrode gel between the skin and metallic part of BioAmp cable to get the best results.

Tip

Visit the complete documentation on how to *assemble and use the BioAmp Bands* or follow the youtube video given below.

Tutorial on how to use the band:

<https://youtu.be/xYZdw0aesa0>

Note

In this demonstration we are recording EMG signals from the ulnar nerve, but you can record EMG from other areas as well (biceps, triceps, legs, jaw etc) as per your project requirements. Just make sure to place the IN+, IN- electrodes on the targeted muscle and REF on a bony part.

Uploading the code

Connect the Arduino Uno to your laptop using the USB cable (Type A to Type B). Copy paste any one of the Arduino Sketches given below in Arduino IDE v1.8.19 that you downloaded earlier:

EMG Filter

EMG Envelope

Go to **tools** from the menu bar, select **board** option then select **Arduino UNO**. In the same menu, select the **COM** port on which your Arduino Uno is connected. To find out the right **COM** port, disconnect your board and reopen the menu. The entry that disappears should be the right **COM** port. Now upload the code, & open the serial plotter from the **tools** menu to visualize the EMG signals.

After opening the serial plotter make sure to select the baud rate to 115200.

Important

Make sure your laptop is not connected to a charger and sit 5m away from any AC appliances for best signal acquisition.

Visualizing the EMG signals

Now flex your arm to visualize the muscle signals in real time on your laptop.

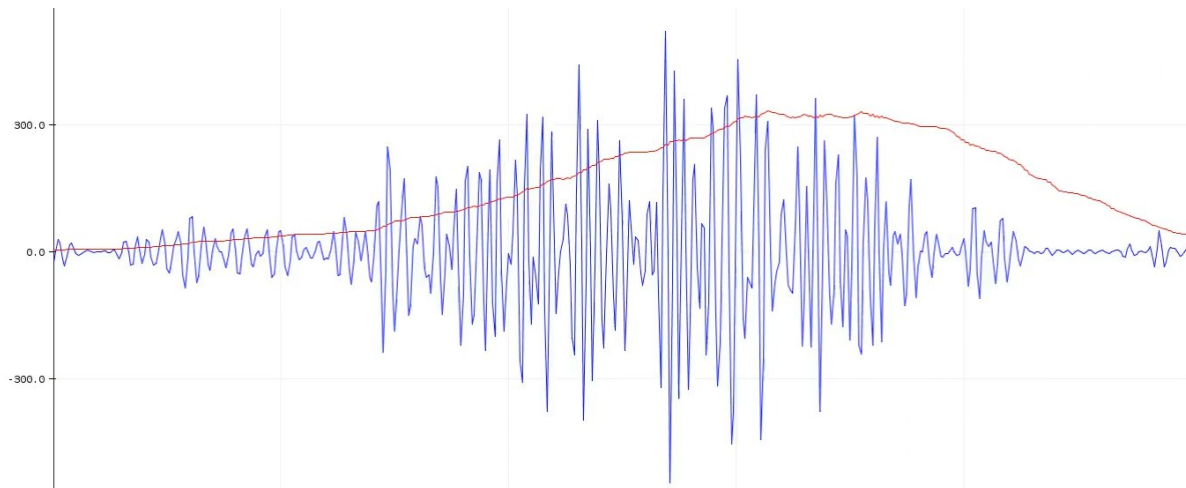

2.6.7 Step 6: Measuring ElectroCardioGraphy (ECG)

Note

Electrocardiography (ECG) is the process of producing an electrocardiogram (ECG or EKG). It is a graph of voltage versus time of the electrical activity of the heart using electrodes placed on the skin. These electrodes detect the small electrical changes that are a consequence of cardiac muscle depolarization followed by repolarization during each cardiac cycle (heartbeat).

Electrodes placement

We have 2 options to measure the ECG signals, either using the gel electrodes or using dry electrode based Heart BioAmp Band. You can try both of them one by one.

- **Using gel electrodes:**

1. Connect the BioAmp cable to gel electrodes
2. Peel the plastic backing from electrodes
3. Place the IN- cable on the left side, IN+ in the middle and REF (reference) on the far right side as shown in the diagram.

- **Using Heart BioAmp Band:**

1. Wear the band as depicted in the video tutorial given below
2. Place the IN- cable on the left side, IN+ in the middle and REF (reference) on the far right side.

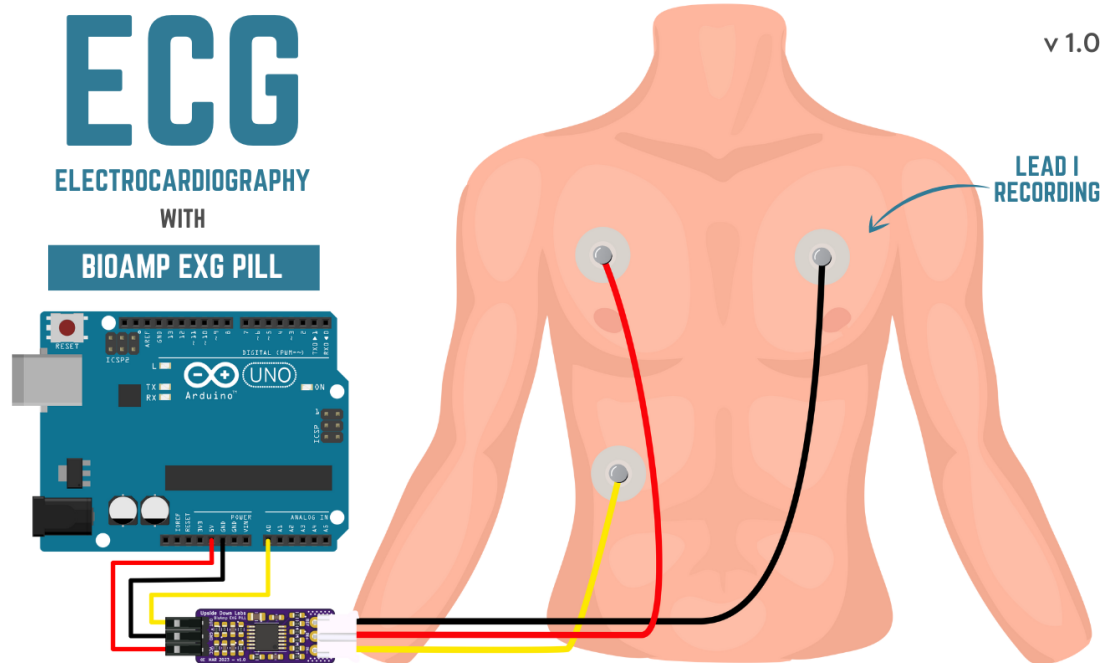

3. Now put a small drop of electrode gel between the skin and metallic part of BioAmp cable to get the best results.

Tip

Visit the complete documentation on how to *assemble and use the BioAmp Bands* or follow the youtube video given below.

Tutorial on how to use the band:

<https://youtu.be/fr5iORsVyUM>

Uploading the code

Connect Arduino Uno to your laptop using the USB cable (Type A to Type B). Copy paste the Arduino Sketch given below in Arduino IDE v1.8.19 that you downloaded earlier:

ECG Filter

Go to **tools** from the menu bar, select board option then select Arduino UNO. In the same menu, select the COM port on which your Arduino Uno is connected. To find out the right COM port, disconnect your board and reopen the menu. The entry that disappears should be the right COM port. Now upload the code, & open the serial plotter from the tools menu to visualize the signals.

After opening the serial plotter make sure to select the baud rate to 115200.

Important

Make sure your laptop is not connected to a charger and sit 5m away from any AC appliances for best signal acquisition.

Visualizing the ECG signals

Sit back, relax and see your ECG signals in real time on your laptop.

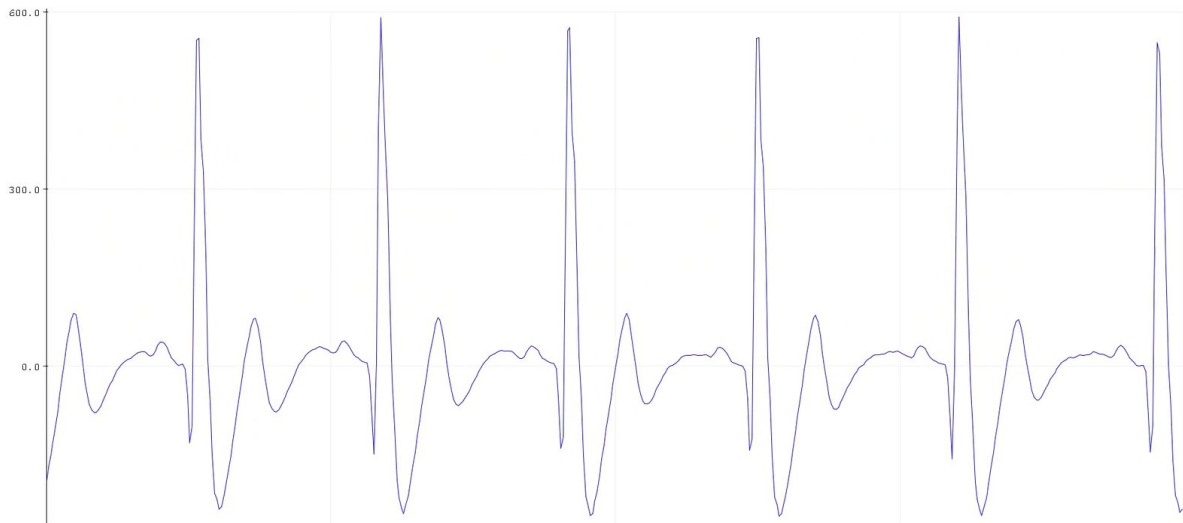

2.6.8 Step 7: Measuring Electrooculography (EOG)

Note

Electrooculography (EOG) is a technique for measuring the corneo-retinal standing potential that exists between the front and the back of the human eye. The resulting signal is called EOG. To measure eye movement, pairs of electrodes are typically placed either above and below the eye or to the left and right of the eye. If the eye moves from the center position toward one of the two electrodes, this electrode “sees” the positive side of the retina, and the opposite electrode “sees” the negative side of the retina. Consequently, a potential difference occurs between the electrodes. Assuming the resting potential is constant, the recorded potential is a measure of the eye’s position.

Electrodes placement

We have 2 ways to measure the EOG signals, either record the horizontal eye movement or the vertical eye movement. You can one by one record both the signals.

- **Horizontal EOG recording:**

1. Connect the BioAmp cable to gel electrodes.
2. Peel the plastic backing from electrodes.
3. Place the IN- cable on the right side of the eye, IN+ on the left side of the eye and REF (reference) at the bony part, on the back side of your earlobe as shown in the diagram above.

- **Vertical EOG recording:**

1. Connect the BioAmp cable to gel electrodes.
2. Peel the plastic backing from electrodes.
3. Place the IN- & IN+ cables above and below the eye respectively and REF (reference) at the bony part, on the back side of your earlobe as shown in the diagram above.

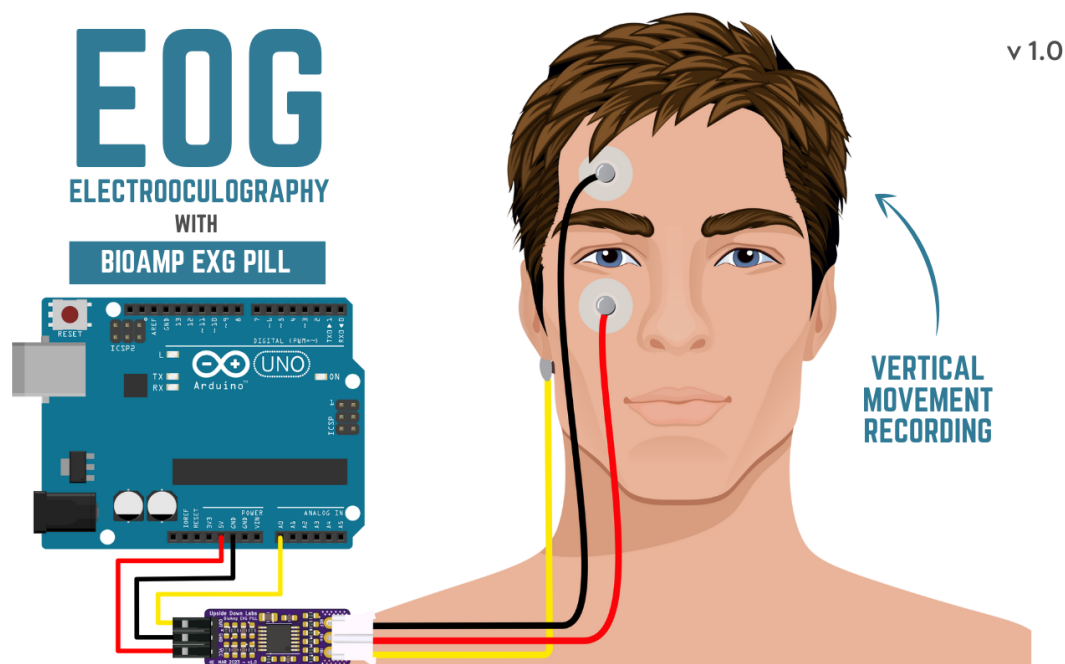
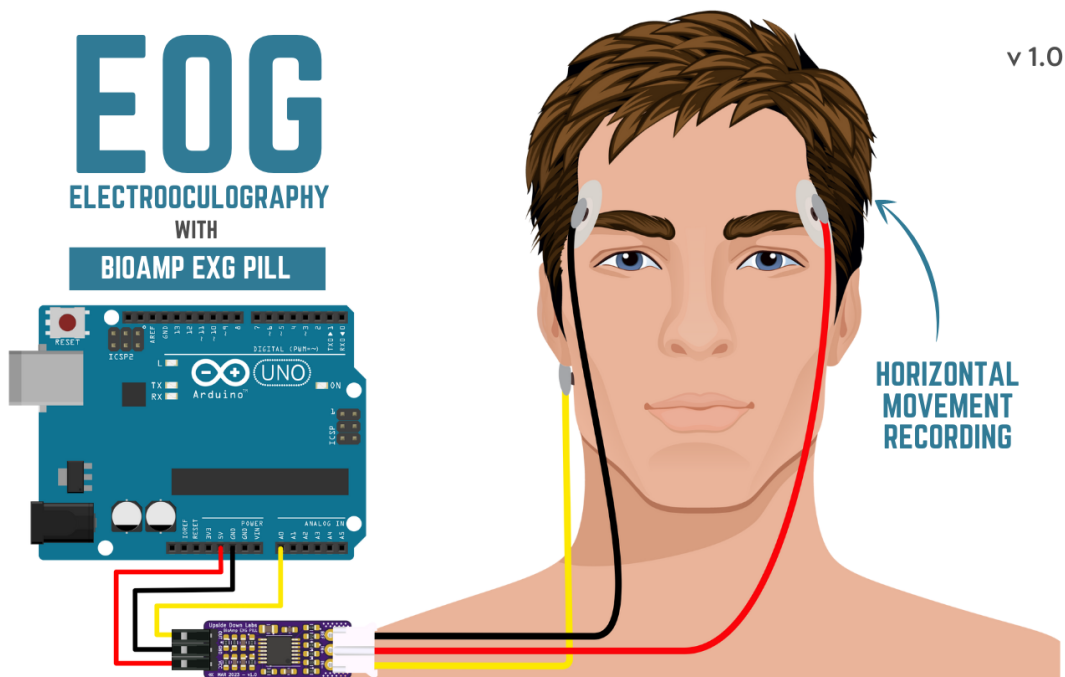

Uploading the code

Connect Arduino Uno to your laptop using the USB cable (Type A to Type B). Copy paste the Arduino Sketch given below in Arduino IDE v1.8.19 that you downloaded earlier:

EOG Filter

Go to **tools** from the menu bar, select **board** option then select **Arduino UNO**. In the same menu, select the **COM** port on which your Arduino Uno is connected. To find out the right **COM** port, disconnect your board and reopen the menu. The entry that disappears should be the right **COM** port. Now upload the code, & open the serial plotter from the tools menu to visualize the signals.

After opening the serial plotter make sure to select the baud rate to 115200.

Important

Make sure your laptop is not connected to a charger and sit 5m away from any AC appliances for best signal acquisition.

Visualizing the EOG signals

Move your eyes up-down or left-right to see your EOG signals in real time on your laptop.

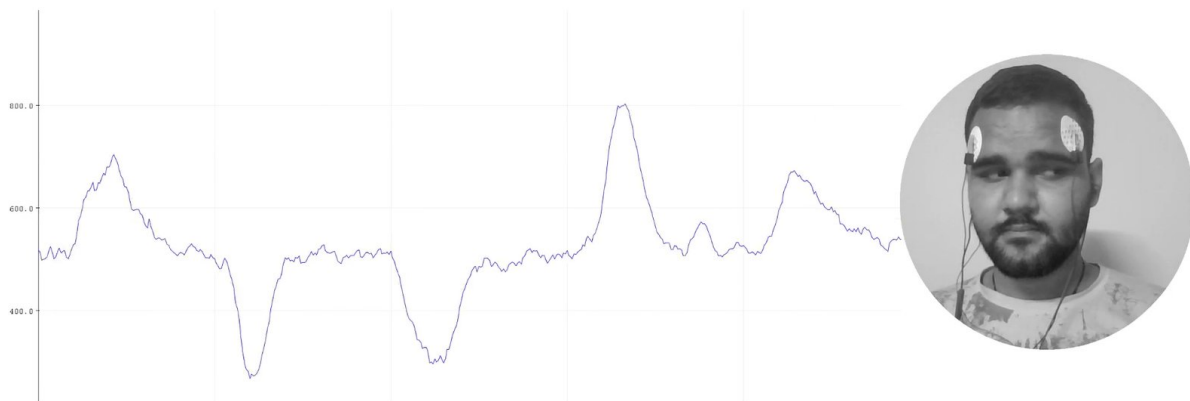

2.6.9 Step 8: Measuring Electroencephalography (EEG)

Note

Electroencephalography (EEG) is an electrophysiological monitoring method to record electrical activity on the scalp. During the procedure, electrodes consisting of small metal discs with thin wires are pasted onto your scalp. The electrodes detect tiny electrical charges that result from the activity of your brain cells which are then amplified to appear on the computer screen. It is typically non-invasive, with the electrodes placed along the scalp.

For recording EEG from different parts of the brain, you have to place the electrodes according to the [International 10-20 system for recording EEG](#).

International 10-20 system
for recording EEG

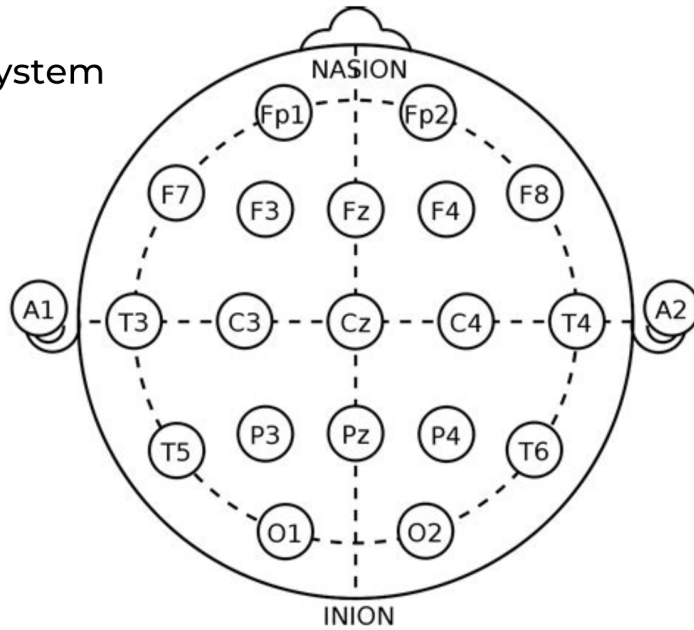

Source: Wikipedia

Electrodes placement

We have 2 options to measure the EEG signals, either using the gel electrodes or using dry electrode based Brain BioAmp Band. You can try both of them one by one.

- Using gel electrodes to record from prefrontal cortex part of brain:

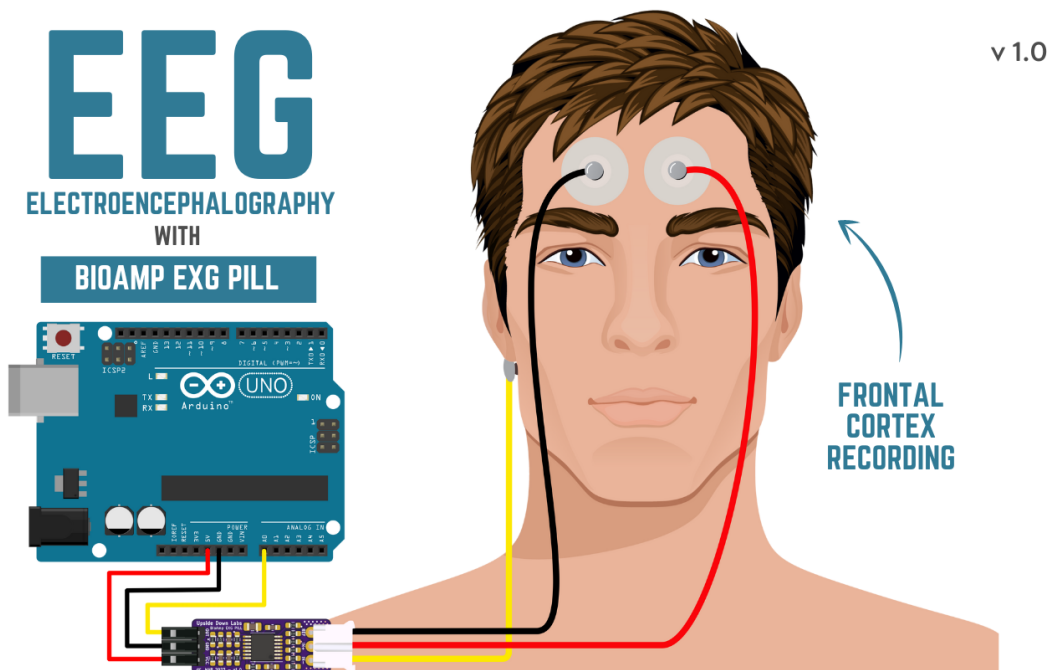

1. Connect the BioAmp cable to gel electrodes.
2. Peel the plastic backing from electrodes.
3. Place the IN+ and IN- cables on Fp1 and Fp2 as per the International 10-20 system & REF (reference) at the bony part, on the back side of your earlobe as shown above.

- Using Brain BioAmp Band to record from prefrontal cortex part of brain:

1. Connect the BioAmp cable to Brain BioAmp Band in a way such that IN+ and IN- are placed on Fp1 and Fp2 as per the International 10-20 system.
2. In this case, the REF (reference) should be connected using gel electrode. So connect the reference of BioAmp cable to the gel electrode, peel the plastic backing and place it at the bony part, on the back side of your earlobe.
3. Now put a small drop of electrode gel on the dry electrodes (IN+ and IN-) between the skin and metallic part of BioAmp cable to get the best results.

Tip

Visit the complete documentation on how to *assemble and use the BioAmp Bands* or follow the youtube video given below.

Tutorial on how to use the band:

<https://youtu.be/O6qp7teT-sM>

Note

Similarly you can use the band to record EEG signals from the visual cortex part of brain by placing the dry electrodes on O1 and O2 instead of Fp1 and Fp2. Everything else will remain the same.

Uploading the code

Connect Arduino Uno to your laptop using the USB cable (Type A to Type B). Copy paste the Arduino Sketch given below in Arduino IDE v1.8.19 that you downloaded earlier:

Spike recorder arduino code

Go to **tools** from the menu bar, select board option then select Arduino UNO. In the same menu, select the COM port on which your development board is connected. To find out the right COM port, screen disconnect your board and reopen the menu. The entry that disappears should be the right COM port. Now upload the code.

Important

Make sure your laptop is not connected to a charger and sit 5m away from any AC appliances for best signal acquisition.

Visualizing the EEG signals

Open the Spike Recorder software. When the Spike Recorder starts, it will start recording from your microphone. To change that, go to the settings by clicking the first icon on the top left corner of the screen, select the COM port on which your Arduino UNO is connected and click on connect.

Mute the speakers and apply the 50Hz notch filter by clicking on the checkbox as shown in the screenshot above. You should set the low band pass filter to 1Hz and high bandpass filter to 40Hz as we are only recording the EEG signals which range between these frequencies.

Now everything is configured and connected. So close the settings window and start recording EEG signals.

The signals that you can see on the screen right now are originating from prefrontal cortex part of your brain and propagating through all the layers to the surface of your skin.

To record these EEG signals, you have placed the electrodes on the forehead (Fp1 & Fp2), then BioAmp EXG Pill is amplifying those signals so that we can detect it and finally sending it to the ADC (Analog to Digital Converter) of your Arduino Uno. Ultimately the signals are being visualized in Spike Recorder software.

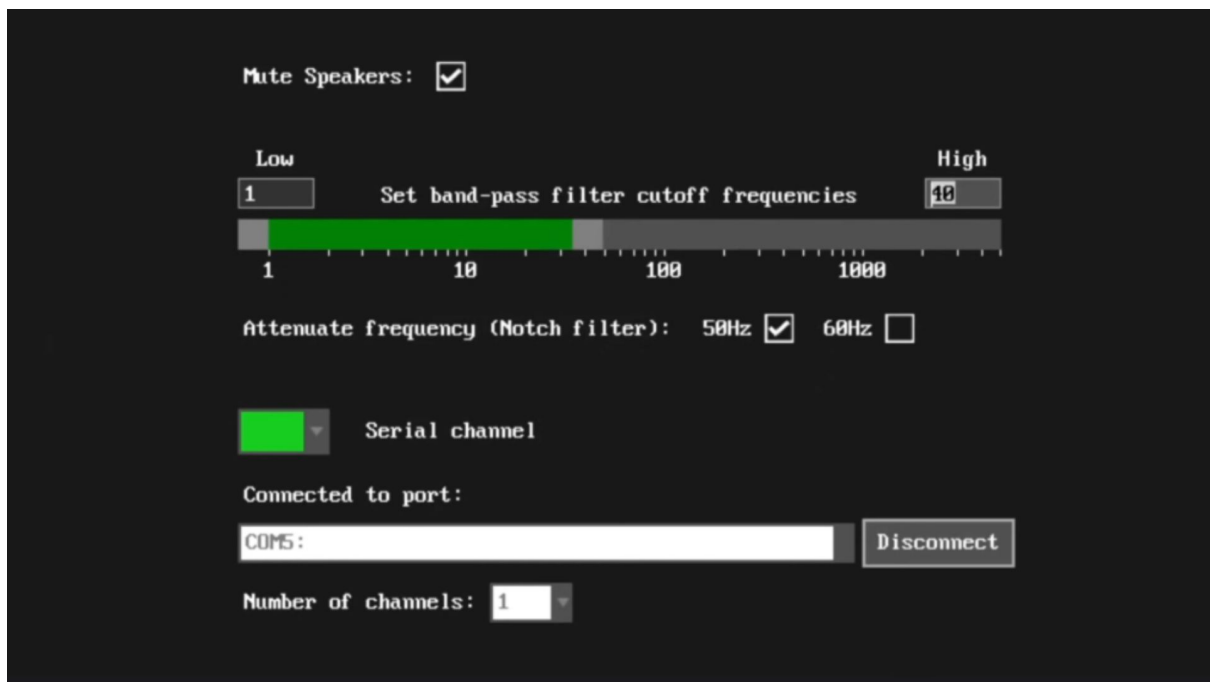

Fig. 5: Spike Recorder settings

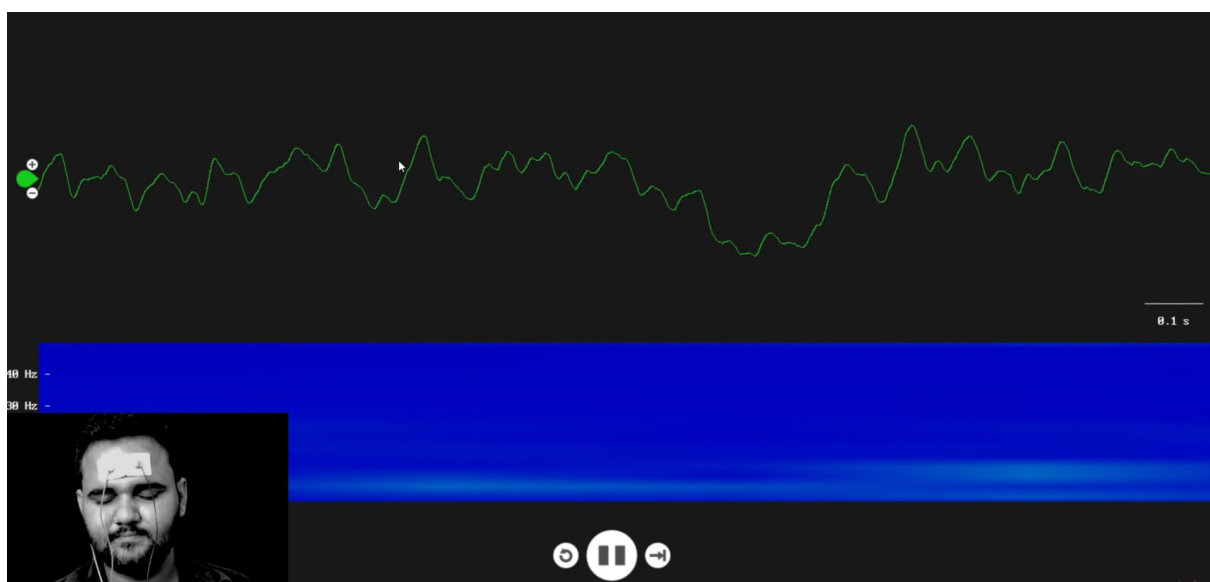

Fig. 6: EEG signals being visualised in Spike Recorder

We hope everything is clear now and you understand how the signals are propagating from your brain to the screen of the laptop.

Features of Spike Recorder that you can explore:

- Increase or decrease the scale of the Y axis by clicking on the + and - icons respectively that is present on the left side of the graph.
- Increase or decrease the X axis timescale by sliding up and down on the scroll wheel of the mouse.
- Visualize the FFT graph by clicking on the FFT icon on top left size of the screen.
- Record the data in .wav format by clicking the record icon on the top right corner. You can convert this data in any other format according to your project requirements.
- Listen to the signals by clicking the volume icon on the top right corner. No don't smile right now, that's how your brain sounds like :P

2.7 Glimpses of previous versions

The BioAmp EXG Pill can be used in a variety of ways, the YouTube video below shows a potential way of using v0.7 of BioAmp EXG Pill.

<https://youtu.be/-G3z9fvQnuw>

A lot has improved in terms of interference rejection and flexibility from v0.7 to v1.0 of the BioAmp EXG Pill. The YouTube video below shows the ECG, EMG, EOG, and EEG recording using v1.0b of device.

<https://youtu.be/z9-B9bHWuhg>

2.8 Real-world Applications

BioAmp EXG Pill is perfect for researchers, makers, and hobbyists looking for novel ways to sample biopotential data. It can be used for a wide variety of interesting biosensing projects, including:

- AI-assisted detection of congestive heart failure using CNN (ECG)
- Heart-rate variability calculation to detect heart ailments (ECG)
- Prosthetic arm (servo) control (EMG)
- Controlling a 3DOF robotic arm (EMG)
- Real-time game controllers (EOG)
- Blink detection (EOG)
- Capturing photos with a blink of an eye (EOG) and many more examples.

2.9 Project ideas & tutorials

You can find step-by-step tutorials for various HCI/BCI projects on our [Instructables](#).

Below are some project ideas that you can try making at your home.

1. Controlling video game using brainwaves (EEG)
2. Visualising electrical impulses from eyes (EOG)
3. Recording EEG from visual cortex part of brain
4. Recording EEG from prefrontal cortex part of brain
5. Eye blink detection

6. Creating a drowsiness detector
7. Record publication-grade ECG
8. Measuring heart rate
9. Detecting heart beats
10. Record publication-grade EMG
11. Detecting up and down movement of eyes

These are some of the project ideas but the possibilities are endless. So create your own Human Computer Interface (HCI) and Brain Computer Interface (BCI) projects and share them with us at contact@upsidedownlabs.tech

2.10 Software tutorials

1. Getting started with Backyard Brains' Spike Recorder

<https://youtu.be/QzZh243-Ac8>

2. Getting started with Brainbay

<https://youtu.be/8vKYAg9C8Jg>

MUSCLE BIOAMP SHIELD

v0.3

3.1 Overview

Muscle BioAmp Shield is an all-in-one Arduino Uno ElectroMyography (EMG) shield for learning neuroscience with ease which is inspired from BackYard Brains (BYB) [Muscle Spiker shield](#) and provides similar features like hobby servo output, user buttons, LED Bar, Audio output, and battery input. It is perfect for beginners as they can easily stack it on top of Arduino Uno to record, visualize and listen to their muscle signals to make amazing projects in the domain of Human-Computer Interface (HCI).

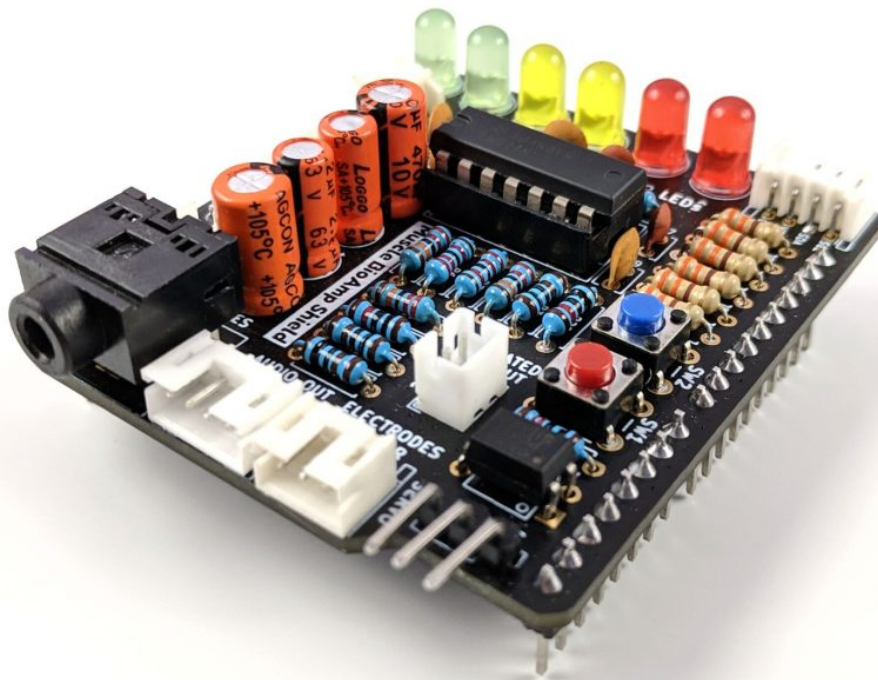

3.2 Features & Specifications

Muscle BioAmp Shield comes with various plug-and-play options so you can connect hundreds of extension boards like OLED screens, character displays, accelerometers, and servo controllers to name just a few using the STEMMA I2C interface. You also get STEMMA digital and STEMMA analog ports. On STEMMA analog port you can connect additional BioAmp EXG Pill or any other sensor with analog output. On STEMMA digital port you can connect any digital sensor or actuator of your choice.

Input Voltage	5V
Input Impedance	10^{11} ohm
Fixed Gain	x2420
Bandpass filter	72 – 720 Hz
Compatible Hardware	Arduino UNO
BioPotentials	EMG (Electromyography)
No. of channels	1
Electrodes	3 (Positive, Negative, and Reference)
Dimensions	6.0 x 5.3 cm
Open Source	Hardware + Software

3.3 Hardware

Images below shows a quick overview of the hardware design.

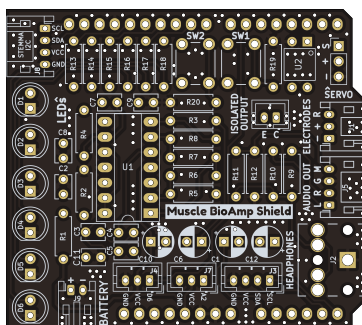

Fig. 1: PCB Front

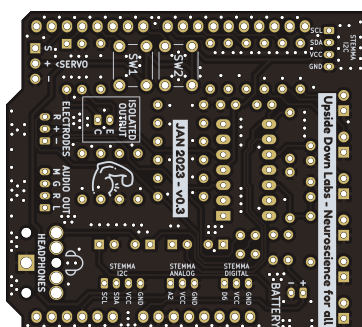

Fig. 2: PCB Back

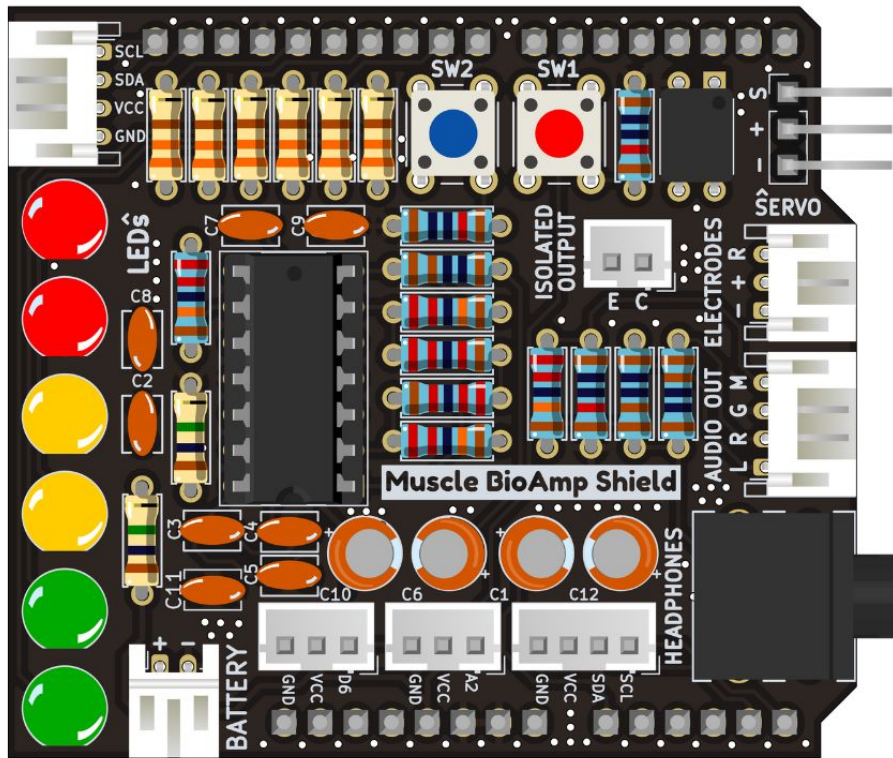

Fig. 3: Assembled PCB

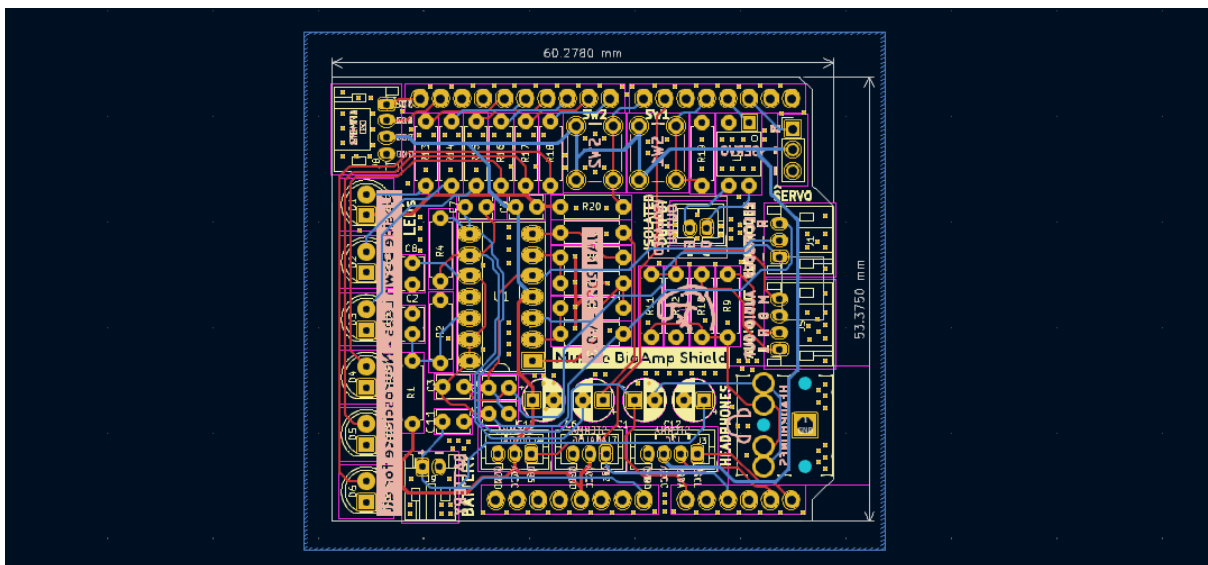

Fig. 4: PCB Layout

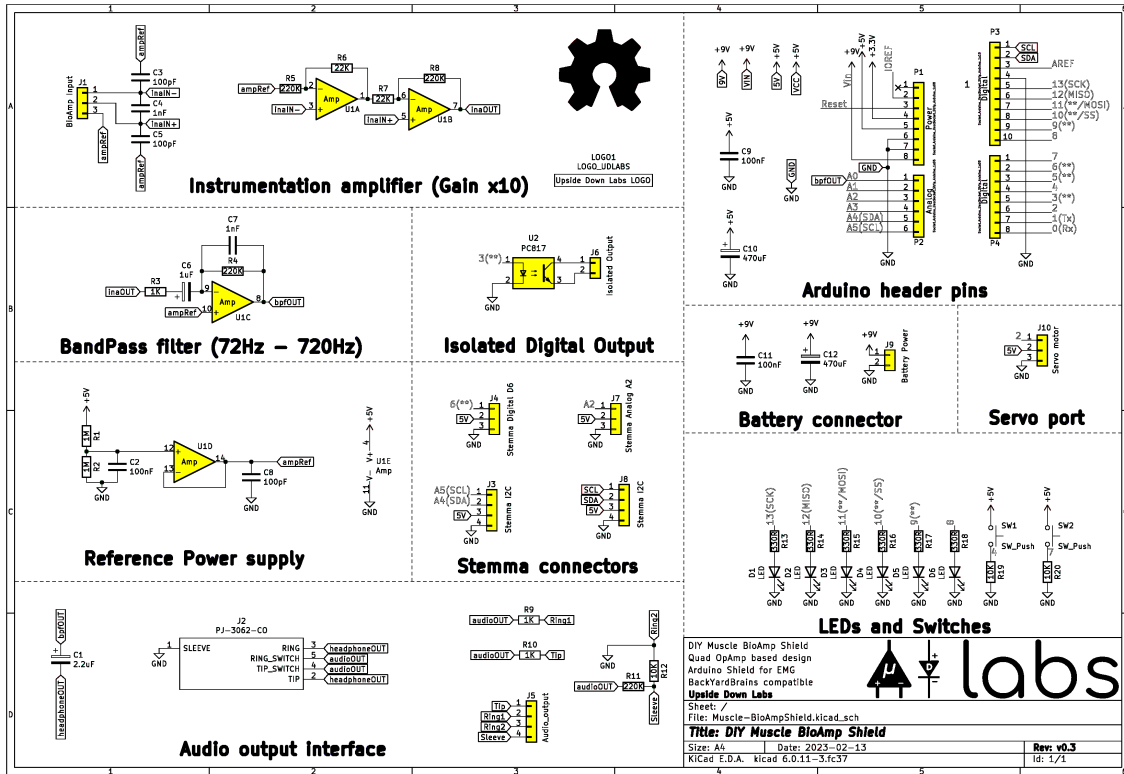

Fig. 5: Schematic Diagram

3.4 Contents of the kit

There are 2 variants available for Muscle BioAmp Shield v0.3 kit - one comes with the shield assembled and the other one contains bare PCB of the sensor and the components separately which you can assemble pretty easily.

Click on the link below to see the unboxing of the kit:

<https://youtu.be/w8yw12SUe6Q>

3.5 Software requirements

Before you start using the kit, please download [Arduino IDE v1.8.19 \(legacy IDE\)](#). Using this you'll be able to upload the arduino sketches on your development board and visualise the data on your laptop.

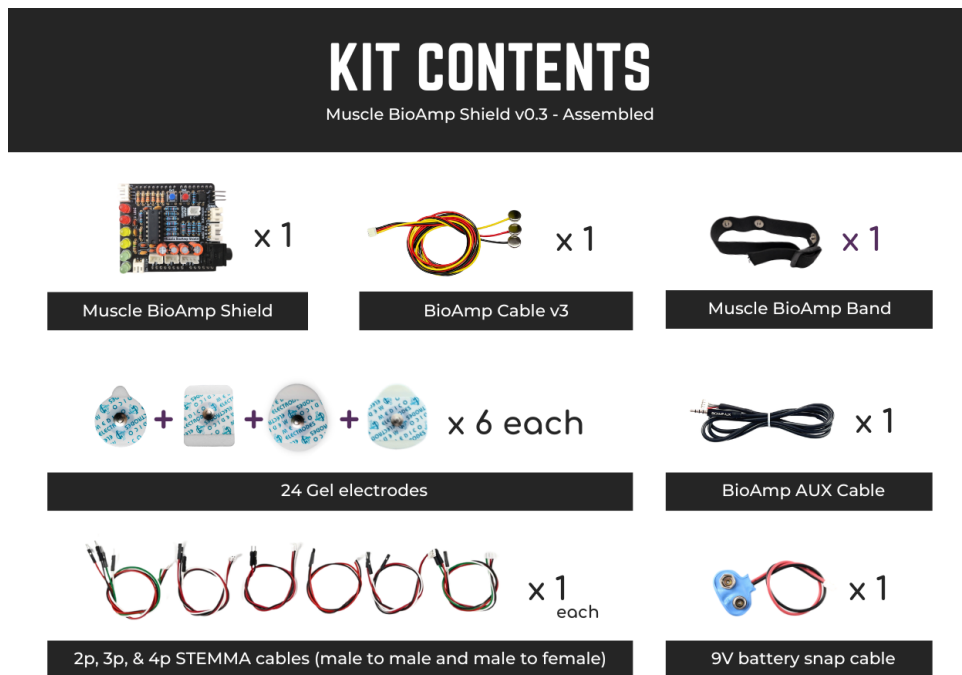

Fig. 6: Assembled Muscle BioAmp Shield kit content

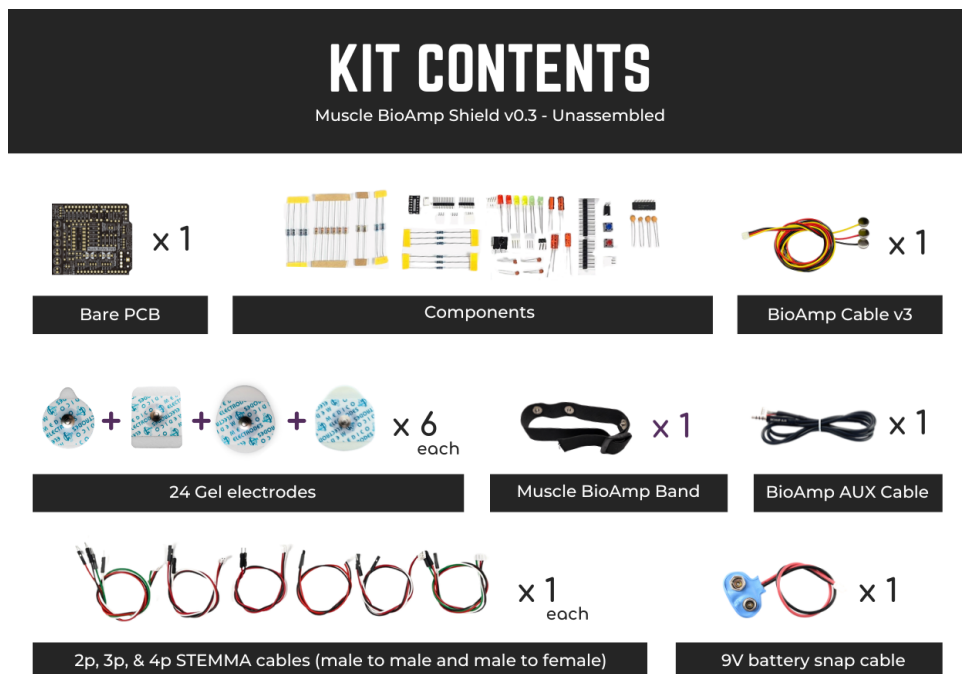

Fig. 7: Unassembled Muscle BioAmp Shield kit content

Legacy IDE (1.8.X)

Fig. 8: Download Arduino IDE v1.8.19

3.6 Using the Sensor

3.6.1 Step 1: Stack on Arduino Uno

Stack the Muscle BioAmp Shield on top of Arduino Uno properly.

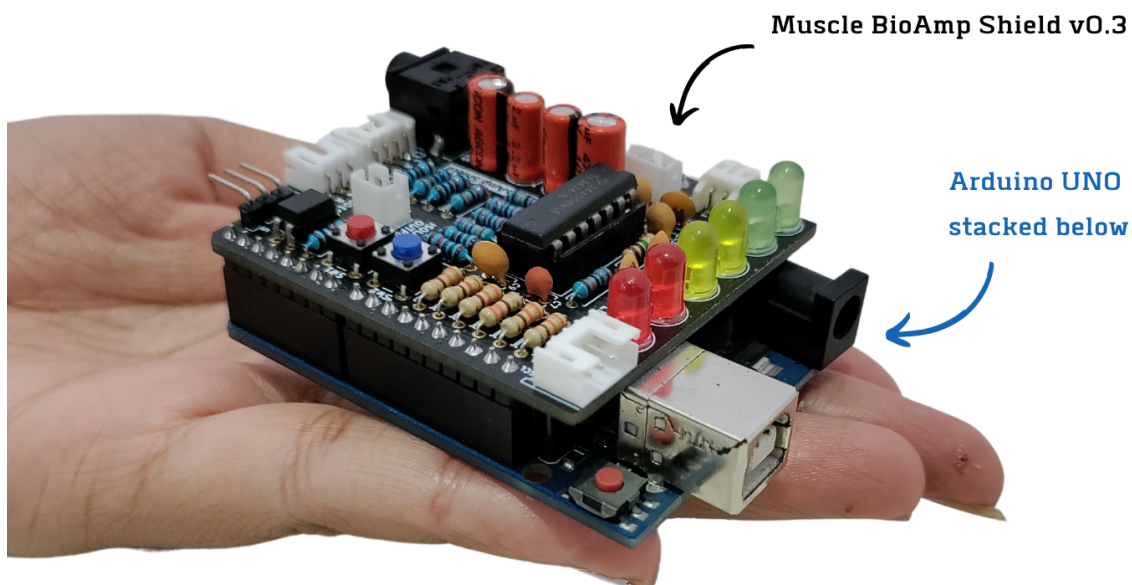

3.6.2 Step 2: Connecting Electrode Cable

Connect the BioAmp Cable to Muscle BioAmp Shield as shown.

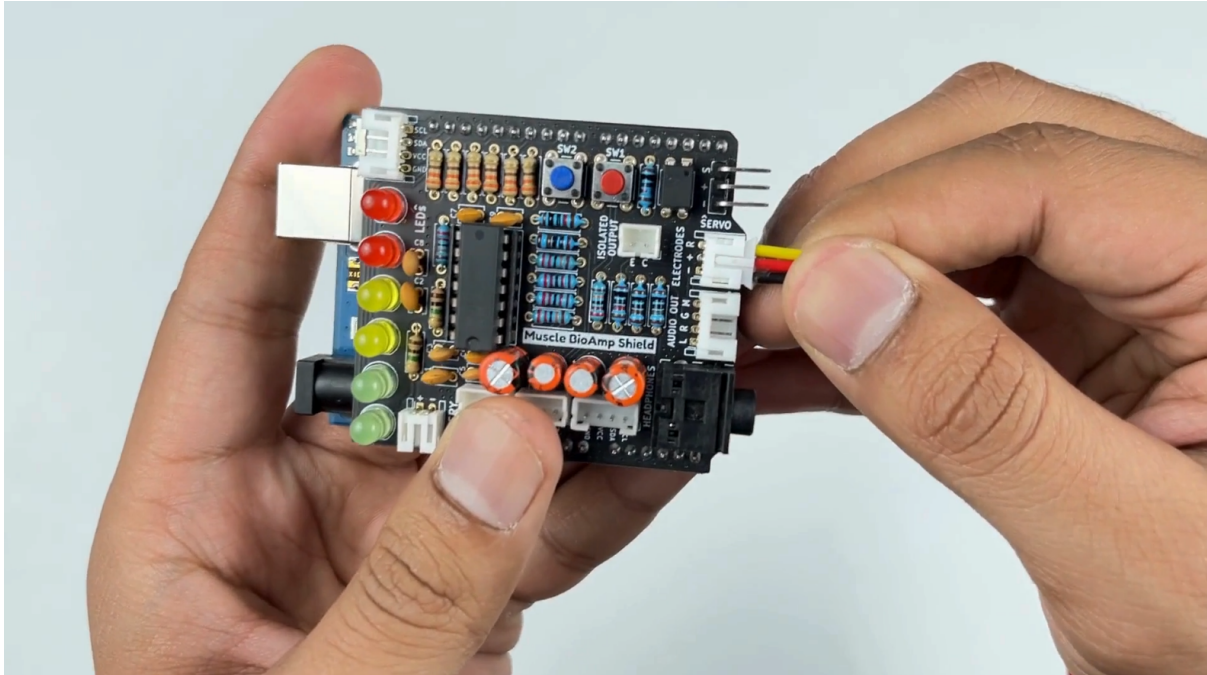

3.6.3 Step 3: Skin Preparation

Apply Nuprep Skin Preparation Gel on the skin surface where electrodes would be placed to remove dead skin cells and clean the skin from dirt. After rubbing the skin surface thoroughly, clean it with an alcohol wipe or a wet wipe.

For more information, please check out detailed step by step [Skin Preparation Guide](#).

3.6.4 Step 4: Electrode Placements

We have 2 options to measure the EMG signals, either using the gel electrodes or using dry electrode based Muscle BioAmp Band. You can try both of them one by one.

Using gel electrodes

1. Connect the BioAmp cable to gel electrodes,
2. Peel the plastic backing from electrodes
3. Place the IN+ and IN- cables on the arm near the ulnar nerve & REF (reference) at the back of your hand as shown in the connection diagram.

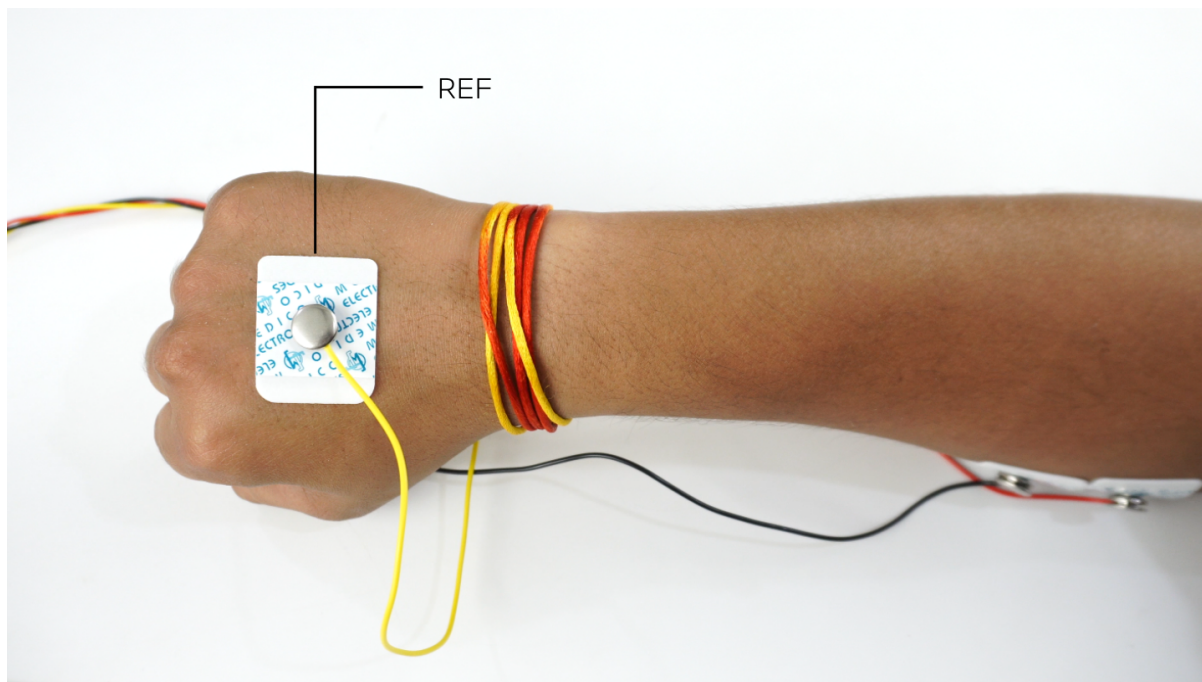

Fig. 9: *Electrode placement for REF cable*

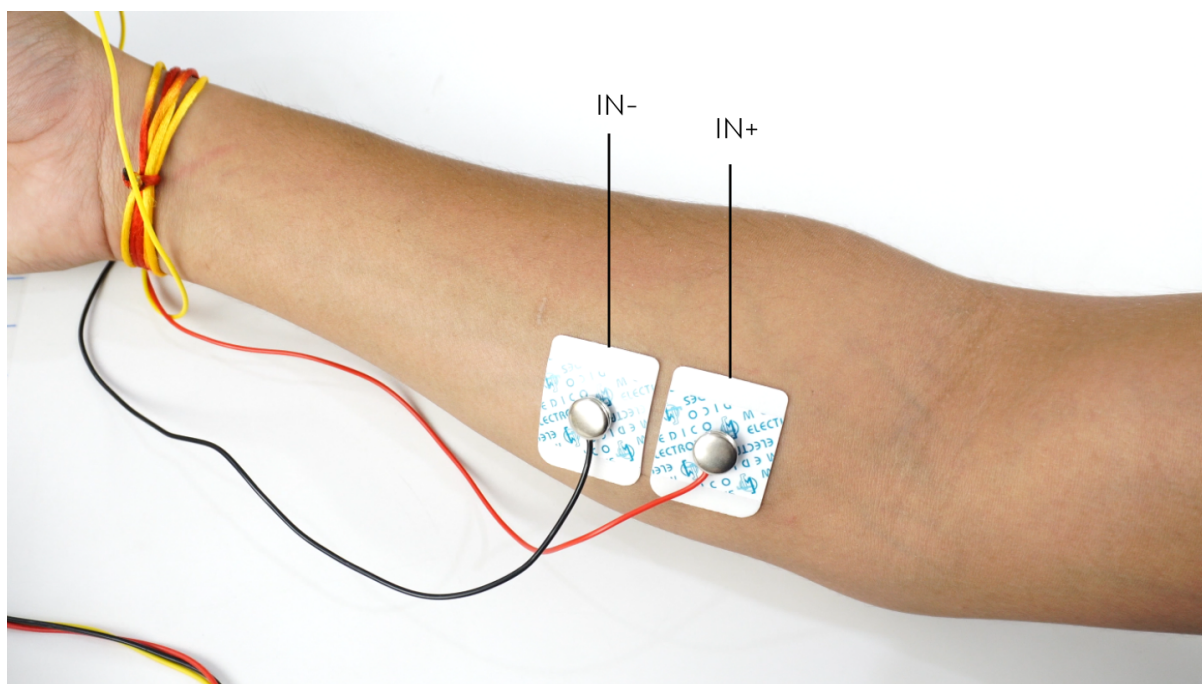

Fig. 10: *Electrode placement for IN+, IN- cables*

Using Muscle BioAmp Band

1. Connect the BioAmp cable to Muscle BioAmp Band in a way such that IN+ and IN- are placed on the arm near the ulnar nerve & REF (reference) on the far side of the band.
2. Now put a small drop of electrode gel between the skin and metallic part of BioAmp cable to get the best results.

Tip

Visit the complete documentation on how to *assemble and use the BioAmp Bands* or follow the youtube video given below.

Tutorial on how to use the band:

<https://youtu.be/xYZdw0aesa0>

Note

In this demonstration we are recording EMG signals from the ulnar nerve, but you can record EMG from other areas as well (biceps, triceps, legs, jaw etc) as per your project requirements. Just make sure to place the IN+, IN- electrodes on the targeted muscle and REF on a bony part.

3.6.5 Step 5: Connect Arduino UNO to your laptop

Connect your Arduino UNO R3 to your laptop using the USB cable (Type A to Type B).

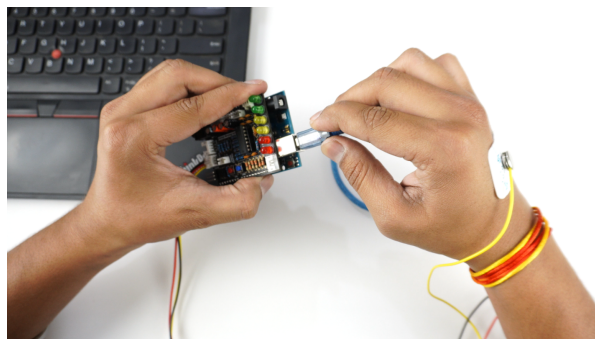
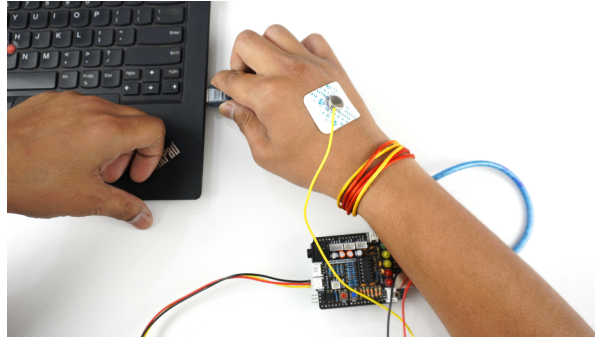

Warning

Make sure your laptop is not connected to a charger and sit 5m away from any AC appliances for best signal acquisition.

3.6.6 Step 6: Visualise EMG signals on laptop

Copy paste any one of the arduino sketches given below in Arduino IDE v1.8.19 that you downloaded earlier:

EMG Filter

EMG Envelope

Go to tools from the menu bar, select board option then select Arduino UNO. In the same menu, select the COM port on which your Arduino Uno is connected. To find out the right COM port, disconnect your board and reopen the menu. The entry that disappears should be the right COM port. Now upload the code, & open the serial plotter from the tools menu to visualize the EMG signals.

After opening the serial plotter make sure to select the baud rate to 115200.

Now flex your arm to visualize the muscle signals in real time on your laptop.

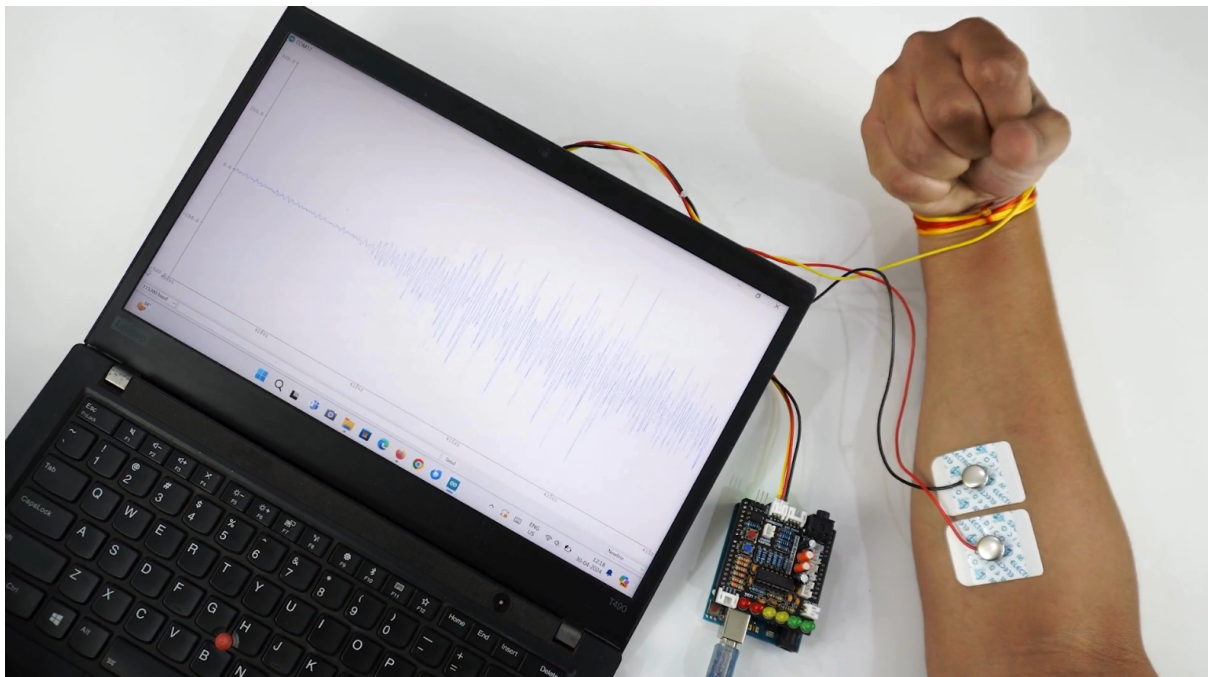

Fig. 11: Visualise EMG signals on laptop

3.6.7 Step 7: Visualise EMG signals on LEDs

Copy paste the Arduino Sketch given below in Arduino IDE:

LED Bar Graph

Make sure you have selected the right board and COM port. Now upload the code, and flex your arm. You'll see the LED bar going up. More strength you apply, more the LED bar goes up.

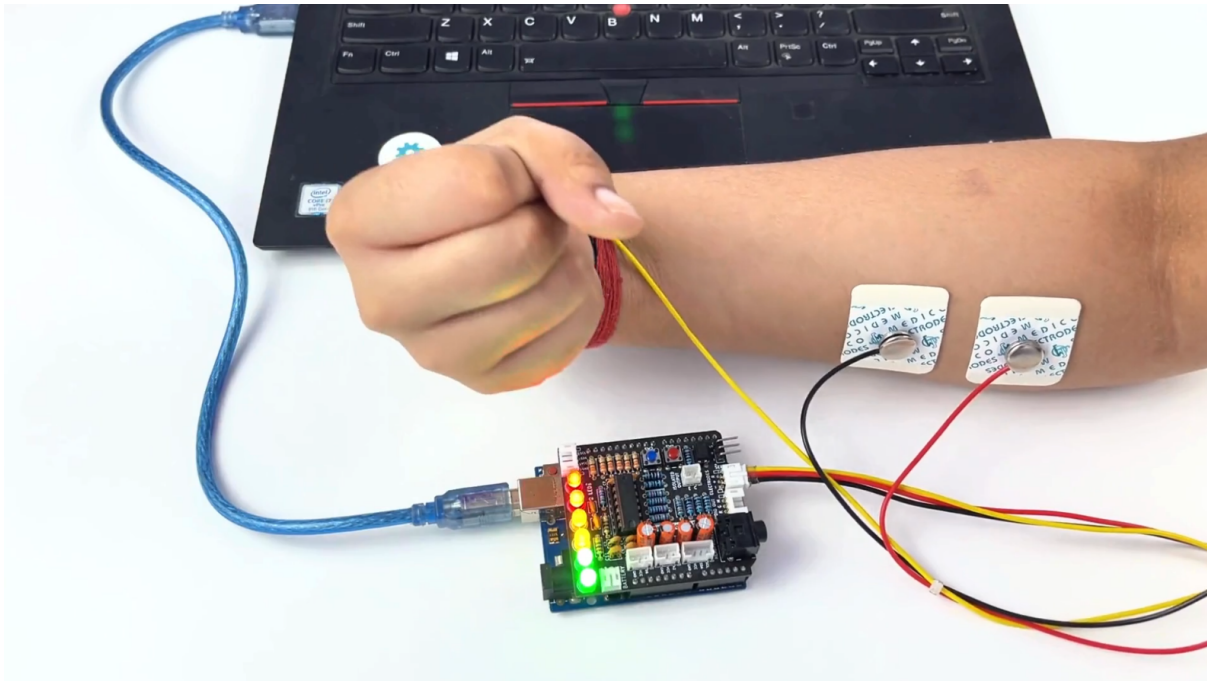

Fig. 12: Visualise EMG signals on LEDs

3.6.8 Step 8: Listen to your EMG signals

You can either listen to the muscle signals (EMG) on a speaker or wired earphones/headphones. Let's try both of them.

Listening EMG on speakers

1. Connect the BioAmp AUX cable on a bluetooth speaker that have 3.5mm jack support.
2. Switch on the speaker and turn the volume to maximum.
3. Flex and listen to your muscles.

Listening EMG on a wired earphones/headphones

1. Plug your wired earphones or headphones on the 3.5mm jack of BioAmp v1.5.
2. Plug it in your ears.
3. Flex and listen to your muscles.

3.6.9 Step 9: Controlling a servo motor

Connect the servo claw to Muscle BioAmp Shield.

Copy paste the Arduino Sketch given below in Arduino IDE:

Servo Controller

Make sure you have selected the right board and COM port. Now upload the code, and flex your arm to control the servo claw in real time.

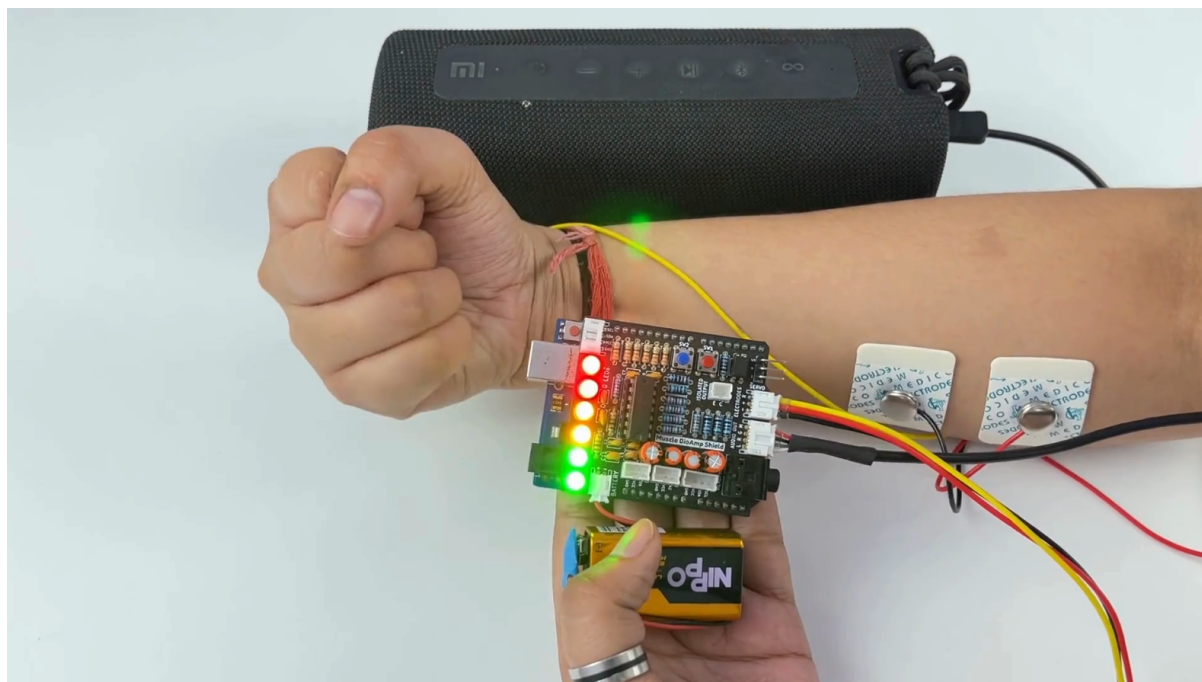

Fig. 13: Listening EMG on speakers

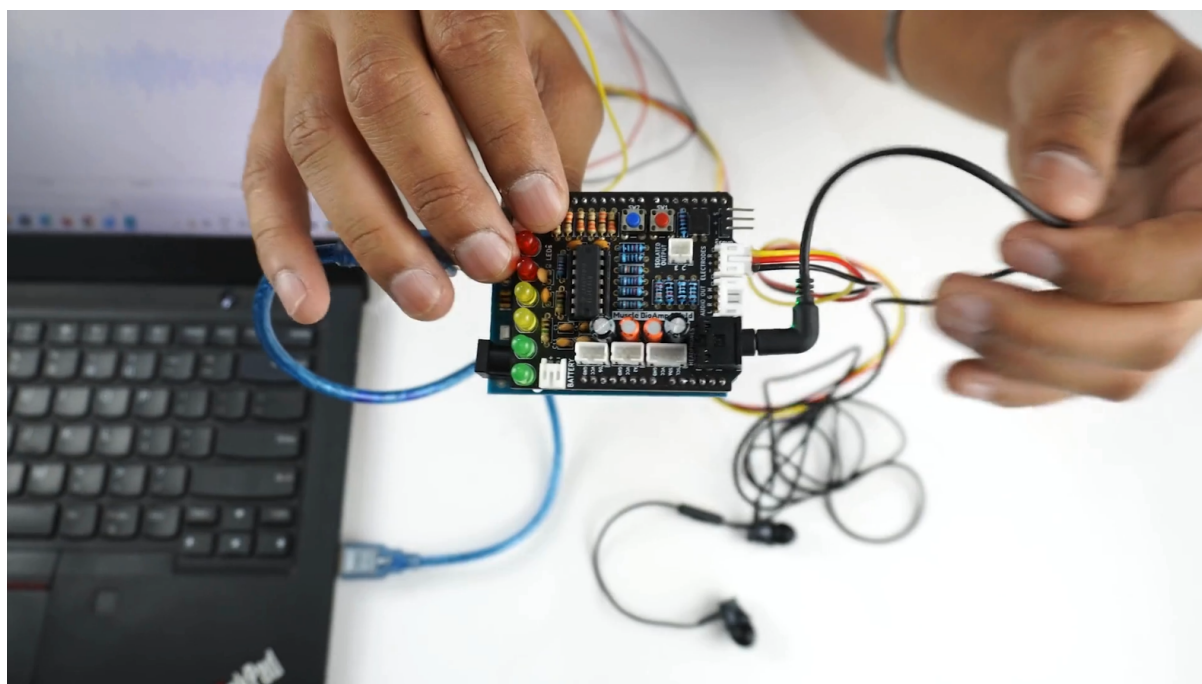

Fig. 14: Listening EMG on a wired earphones/headphones

3.6.10 Step 10: Controlling a servo claw

Connect the servo claw to Muscle BioAmp Shield.

Copy paste the Arduino Sketch given below in Arduino IDE:

Claw Controller

Make sure you have selected the right board and COM port. Now upload the code, and flex your arm to control the servo claw in real time.

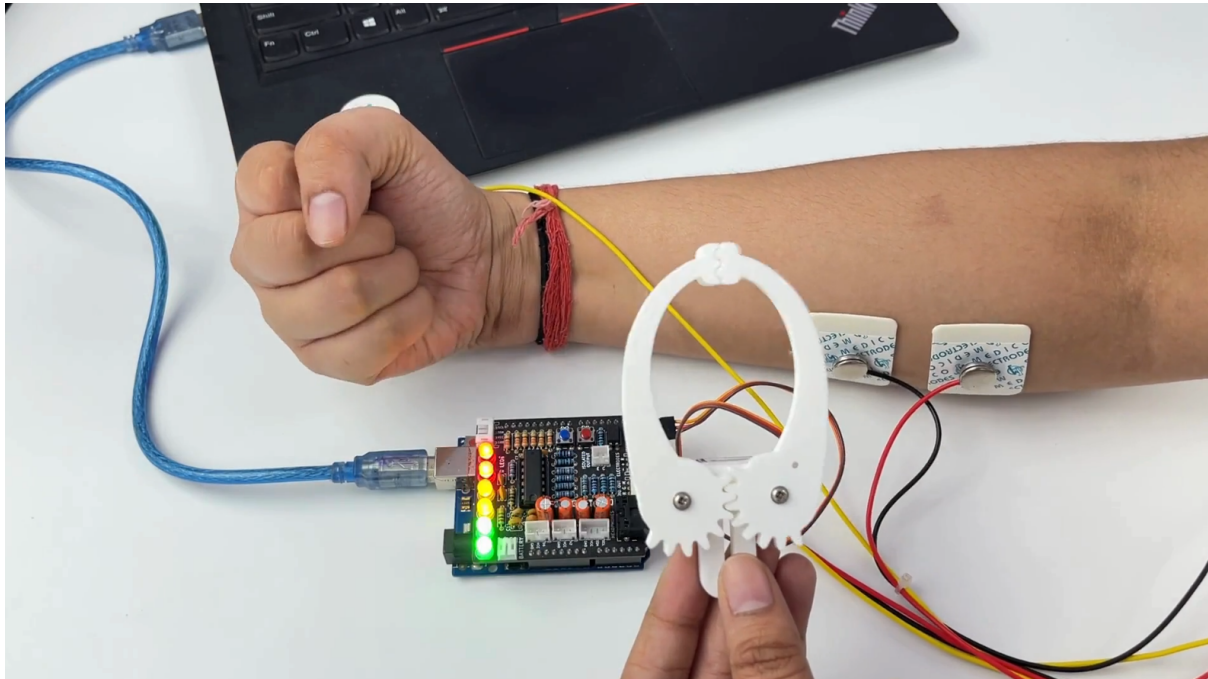

3.6.11 Step 11: Connecting 9V battery

Till now, the power for the EMG system was coming from the laptop via USB cable of Arduino Uno but there can be 2 ways in which you can make the system portable:

- **Using 9V battery:** Directly connect a 9V battery to Muscle BioAmp Shield using a 9V snap cable.
- **Using Power Bank:** Instead of connecting the USB cable of Arduino Uno to laptop, you can directly connect it to power bank.

Note

Do not use 9V battery while controlling a servo claw using Muscle BioAmp Shield. Instead connect the Arduino UNO to a power bank or directly to your laptop.

3.6.12 Step 12: Other functionalities you can explore

Using I2C ports

There are 2 I2C ports available on Muscle BioAmp Shield and you can connect hundreds of devices having I2C compatibility using the 4-pin JST PH 2.0 mm STEMMA cables provided.

Some of the examples are: OLED screens, character displays, temperature sensors, accelerometers, gyroscopes, light sensors, BioAmp Hardware, etc.

Using STEMMA Digital port

Connect Arduino Uno's D6 digital I/O pins using STEMMA digital connectors.

Using STEMMA Analog port

Connect Arduino Uno's A2 analog input pins using STEMMA analog connectors.

Using user buttons

Program the 2 user buttons according to your project requirements.

SKIN PREPARATION GUIDE

4.1 Why skin preparation is important?

Proper skin preparation is crucial before recording any biopotential signal be it Electrocardiography (ECG), Electromyography (EMG), Electroencephalography (EEG), or Electrooculography (EOG).

- **Clean skin surface:** Removes dead skin cells, oils, & other substances that increases skin impedance.
- **Improve impedance:** Improves the conduction of electrical signals from the body to the recording equipment and minimizes impedance.
- **Electrode-skin contact:** Ensures optimal contact between the electrodes and the skin surface.
- **Signal quality:** Enhances the overall quality of recorded signals, providing clear & reliable data for analysis & improves the ability to capture subtle variations in biopotential signals.
- **Consistency in recordings:** Reduces variability in signal quality, making it easier to make any Human-Computer Interface (HCI), Brain-Computer Interface (BCI) project or a real-world application.
- **Long term adhesion:** Facilitates long-term adhesion & stable placement of electrodes to the skin during extended signal monitoring.

4.2 Kit Contents

Nuprep gel	Mildly abrasive, highly conductive gel that should be applied before placing the electrodes on the skin to improve signal quality & enhances the performance of monitoring electrodes.
Electrode Gel	Highly conductive gel that acts as a coupling agent between dry electrodes and the skin to aid the transmission of biopotential signals like ECG, EMG, EOG, or EEG.
Ten20 paste	Contains the right balance of adhesiveness and conductivity, enabling the dry electrodes to remain in place while allowing the transmittance of biopotential signals.
Alcohol Swabs/Wet wipes	Soft & non-woven pads that helps in cleaning the skin surface and does not leave any residue.
Cotton Swabs	Useful while applying nuprep gel or ten20 paste.

Contents of the kit



NuPrep Gel



Cotton Swabs



Electrode Gel



Alcohol Swabs



Ten20 Paste

4.3 Steps to follow

You can follow the steps given below to do the skin preparation properly:

4.3.1 Step 1: Identify the targeted area

Identify the target area where the gel electrodes or BioAmp Bands will be placed for recording the biopotential signals.

4.3.2 Step 2: Apply NuPrep gel

Take a small amount of NuPrep gel using a cotton swab and apply it on your targeted area.

4.3.3 Step 3: Clean the skin surface

Use gentle, circular motions to rub the gel on the skin surface. This removes all the dead skin cells & improves conductivity.

Warning

Do not rub the gel for too long as it has abrasive properties and may cause skin redness and irritation.

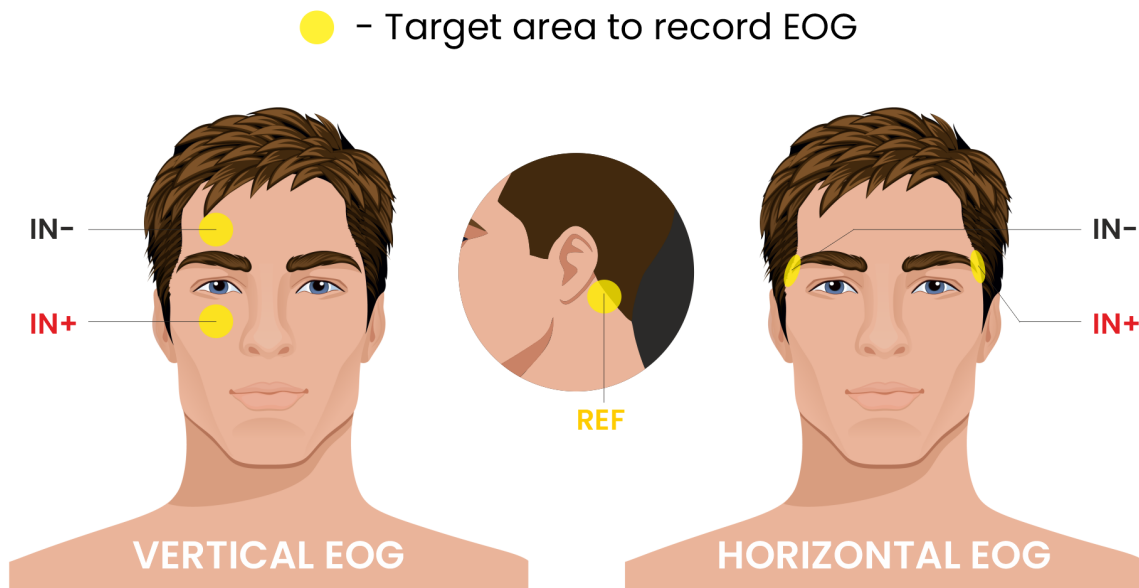

Fig. 1: Target area to record EOG

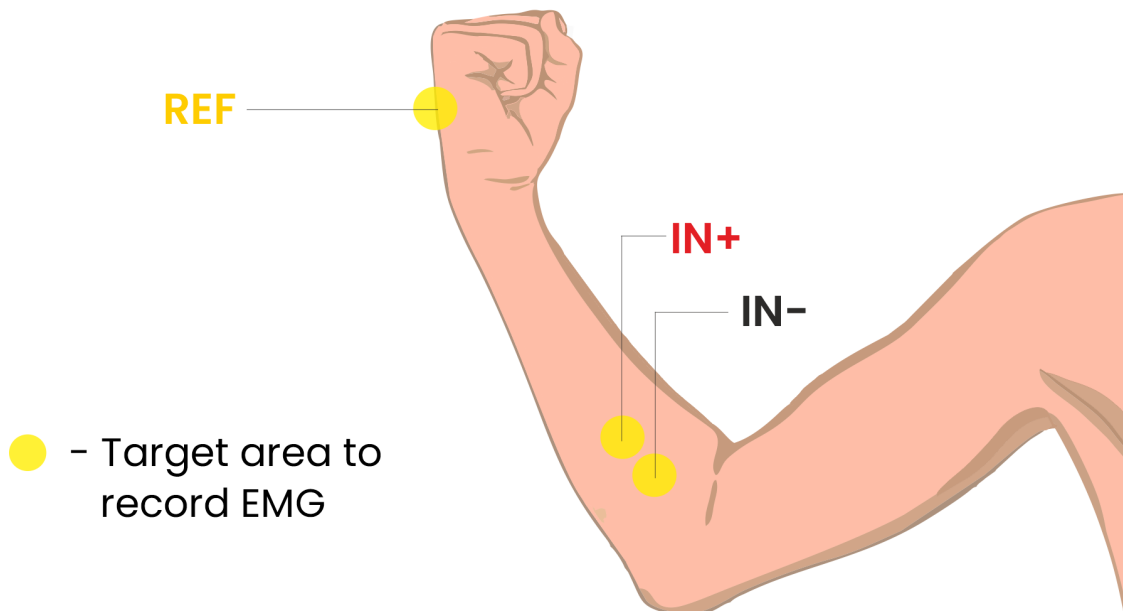

Fig. 2: Target area to record EMG

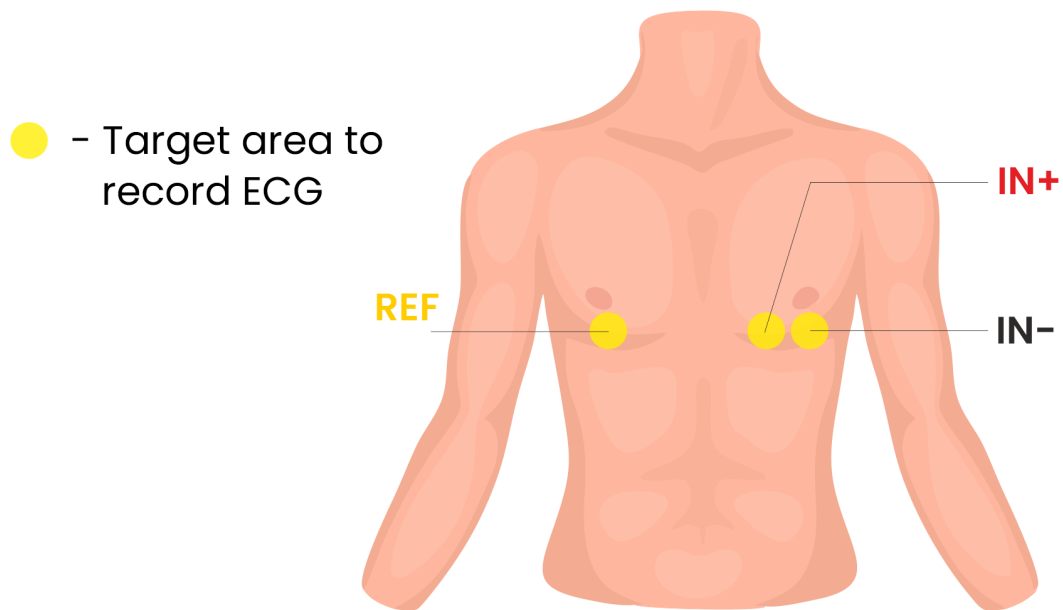

Fig. 3: Target area to record ECG

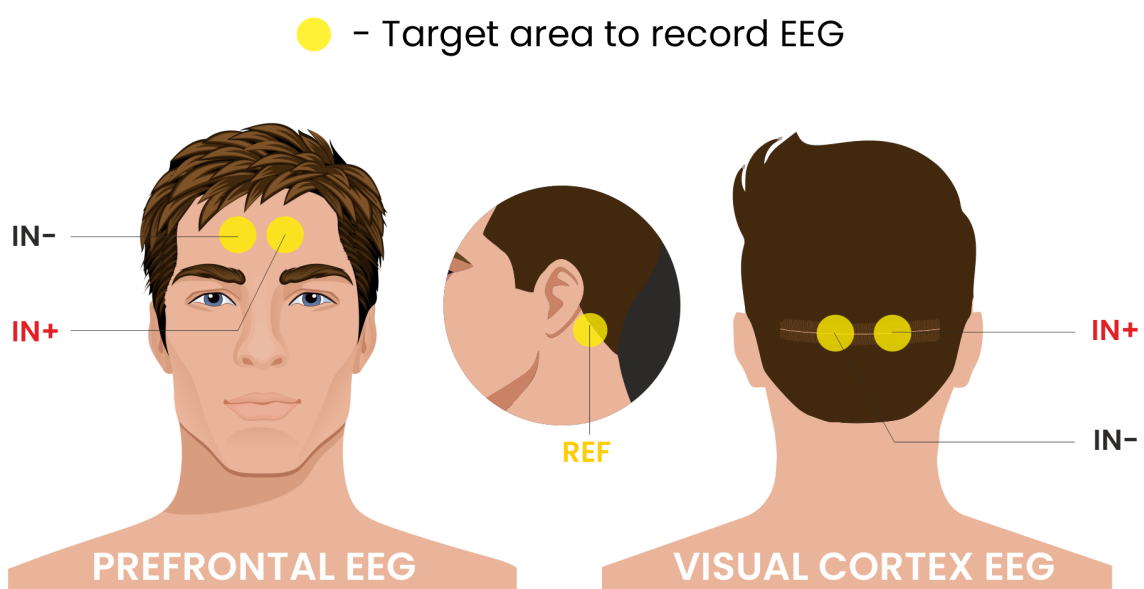

Fig. 4: Target area to record EEG

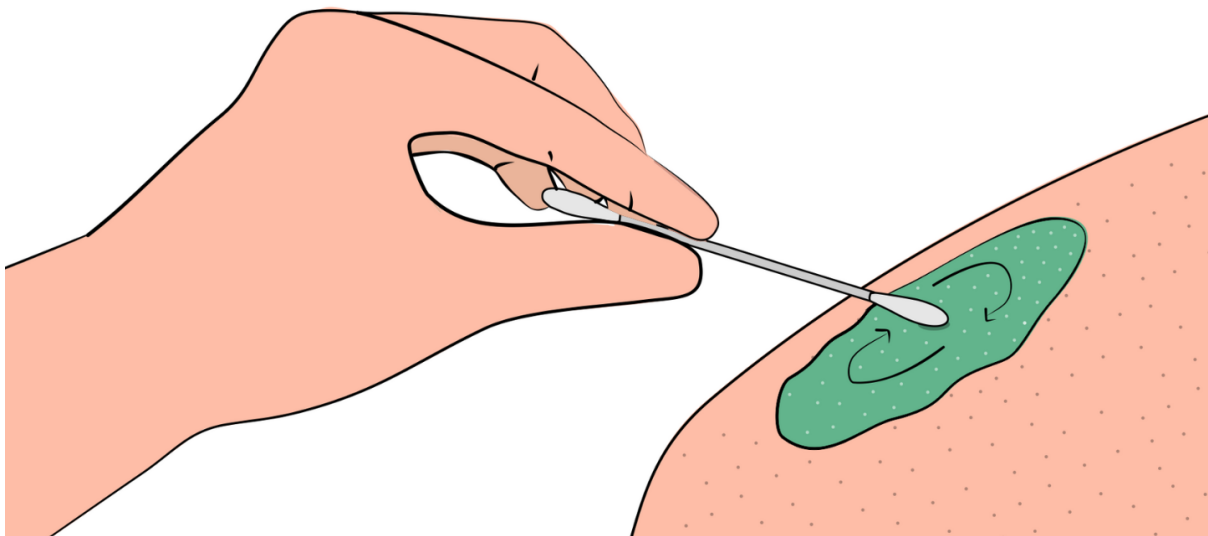
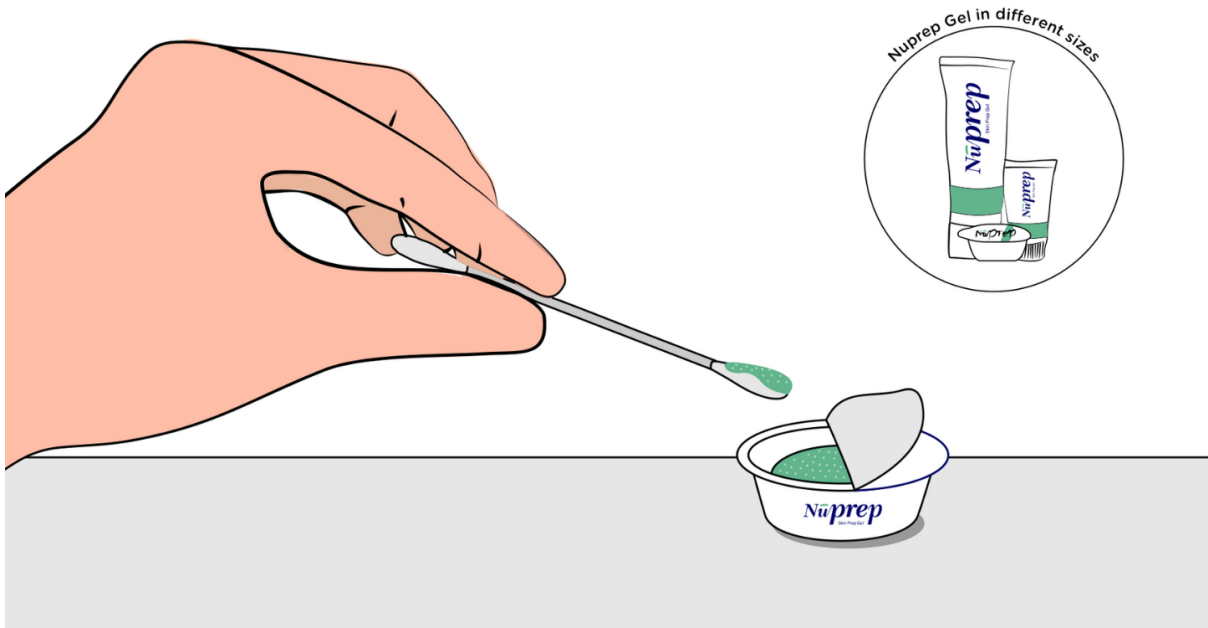

Fig. 5: Rub the gel gently using the cotton swab

4.3.4 Step 4: Wipe off the gel

Wipe away excess gel with alcohol swabs or wet wipes.

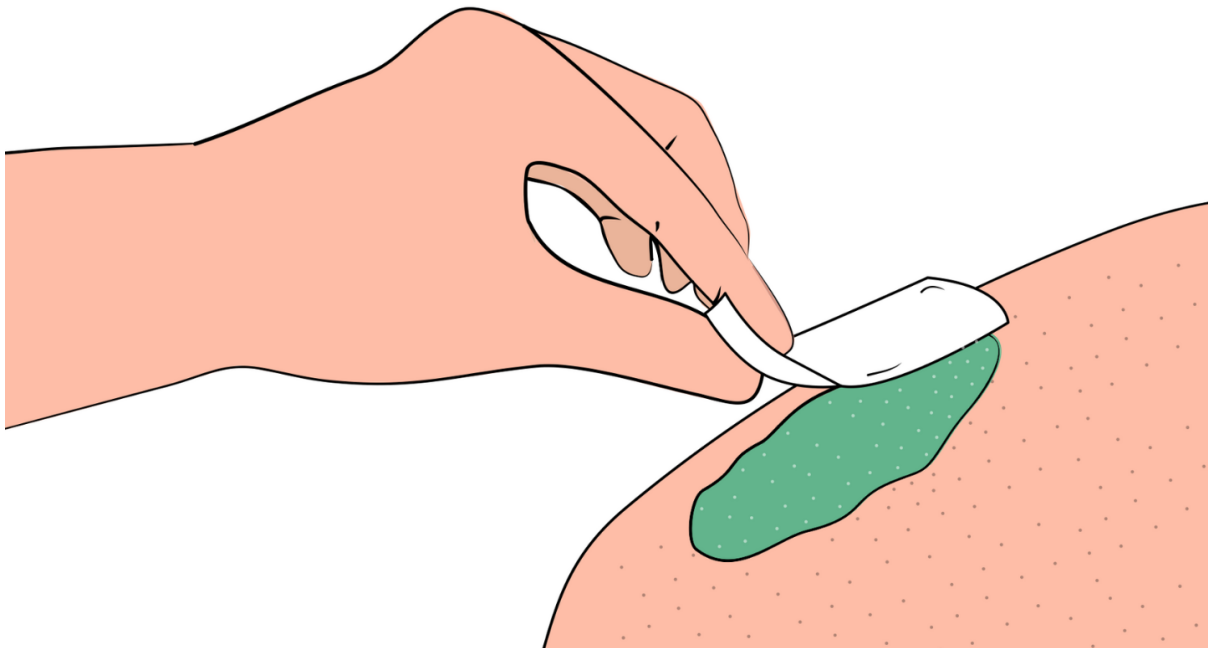

Fig. 6: Wipe away excess gel

Warning

- Using alcohol swabs can dry out the skin, so don't use them if your skin is already dry.
- Close your eyes while using the alcohol swabs for EOG recording else it may cause eye redness & irritation.

4.3.5 Step 5: Measuring the signals

Now you can either use gel electrodes or BioAmp bands for the signal recording.

Using gel electrodes

Connect the BioAmp cable to gel electrodes, peel the plastic backing from electrodes and place the IN+, IN-, REF cables according to your specific biopotential recording.

Note

While placing the gel electrodes on the skin, make sure to place the non-sticky tab of the electrode in the direction opposite to your hair growth. This allows you to remove the electrodes easily without pulling off much body hair.

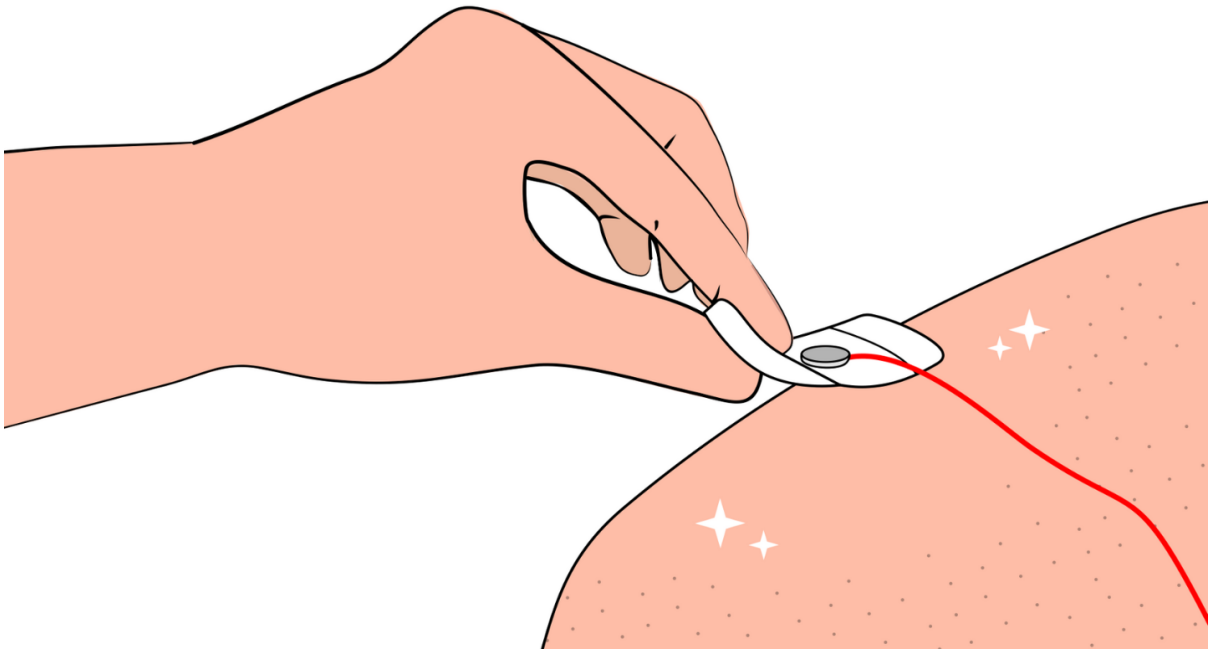

Fig. 7: Placing gel electrodes on skin surface

Using BioAmp bands

Connect the BioAmp cable to your BioAmp band. Now apply a small amount of electrode gel or Ten20 conductive paste on the dry electrodes between the skin and metallic part of BioAmp cable. This improves the signal conductivity, enhancing overall signal quality.

Note

The above graphics demonstrates the use of electrode gel/Ten20 paste with Muscle BioAmp Band. Similarly you can use Brain BioAmp Band and Heart BioAmp Band. Refer to *Using BioAmp Bands* guide to assemble and use all the BioAmp Bands correctly.

Now you are all set! Make all the connections correctly and start recording your biopotential signals.

Warning

NuPrep gel, Ten20 paste and the alcohol swabs shouldn't be used if you have a history of skin allergies to lotions and cosmetics.

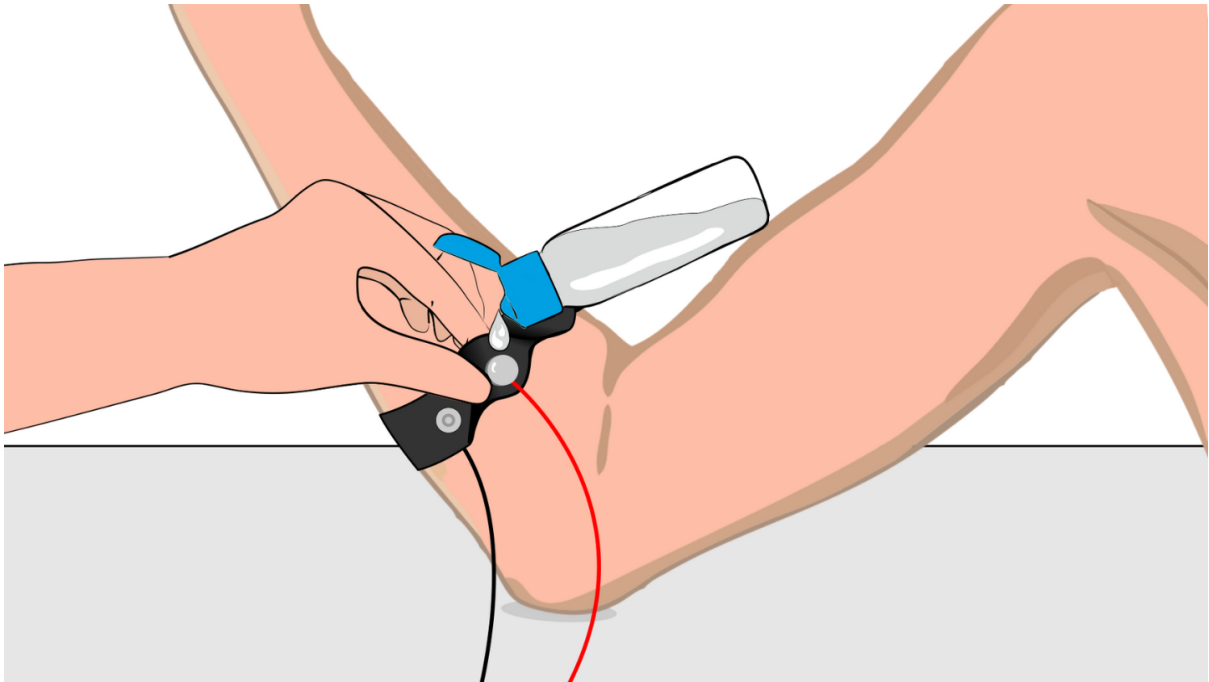

Fig. 8: Method 1: Using Electrode gel

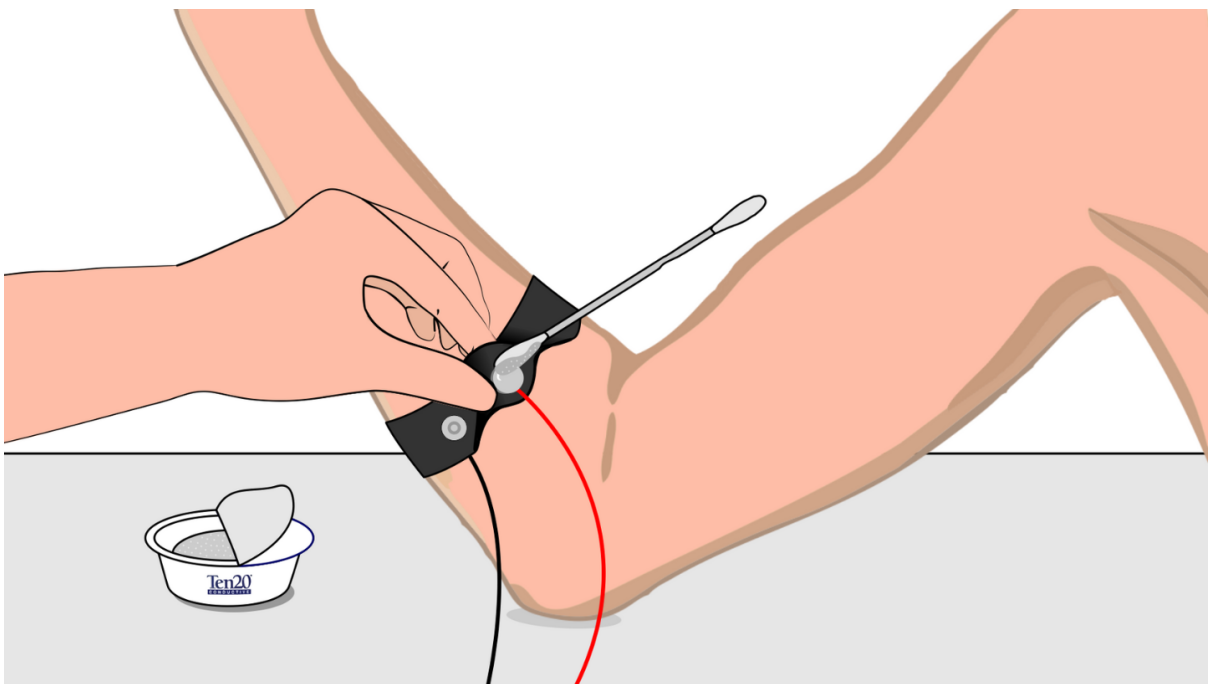

Fig. 9: Method 2: Using Ten20 paste

USING BIOAMP BANDS

5.1 Overview

BioAmp Bands are dry electrode-based stretchable bands that allows you to record biopotential signals from your body be it from brain (EEG), muscles (EMG) or heart (ECG). These bands can only be used with our BioAmp Hardware by making the connections using BioAmp Cable.

5.2 Why use BioAmp Bands?

Usually, people use gel electrodes to record biopotential signals from the skin surface. But, it has its own disadvantages. So we came up with these BioAmp Bands using which users can enjoy a more comfortable, cost-effective, and hassle-free experience while recording biopotential signals.

- **Comfort:** BioAmp Bands are generally more comfortable to wear than gel electrodes, especially for long-term recordings. They conform to the body's shape and avoid the sticky, sometimes irritating sensation of gel electrodes.
- **Reusability:** Unlike gel electrodes, which are often single-use and need to be replaced frequently, BioAmp Bands can be reused multiple times. This makes them more cost-effective and environmentally friendly.
- **Ease of Use:** These bands are easy to wear and adjust, reducing the hassle of setup and ensuring consistent placement.
- **Hygiene:** They can be easily cleaned and sanitized between uses, reducing the risk of skin irritation and infections. Gel electrodes, on the other hand, can leave residue on the skin surface.
- **Performance:** The bands can provide stable and reliable signal recordings depending on your environment conditions. For hot/humid conditions, the bands usually perform better while recording the signals. But if the weather is cold causing dry skin, then it is recommended to prepare the skin properly and apply electrode gel between the metallic part of cable and skin surface. If you feel that the skin impedance is increasing, then reapply electrode gel frequently. The other option is to use gel electrodes after preparing the skin properly.

5.3 Types of BioAmp Bands

There are 3 types of BioAmp Bands and all these bands offer targeted and efficient solutions for recording biopotential signals from the muscles, heart, and brain, making them versatile tools for a wide range of HCI/BCI applications.

5.3.1 1. Muscle BioAmp Band

Muscle BioAmp Band (EMG Band) is a stretchable band that can be connected to any of our Muscle BioAmp Hardware or any EXG sensor using a BioAmp Cable. It allows you to record your muscle signals hassle-free.



Length	13 inches
Stretchability	2X (Upto 26 inches)
Usability	Reusable as it comes with washable fabric
Interface	Snap electrodes
Compatible Hardware	Muscle BioAmp Hardware or any EXG sensor
BioPotentials	EMG
No. of channels	1
Wearable	Yes

5.3.2 2. Heart BioAmp Band

Heart BioAmp Band (ECG Band) is a stretchable band that can be connected to any of our Heart BioAmp Hardware or any EXG sensor using BioAmp Cable. It allows you to record your ECG signals hassle-free.



Length	37 inches
Stretchability	2X (Upto 74 inches)
Usability	Reusable as it comes with washable fabric
Interface	Snap electrodes
Compatible Hardware	Heart BioAmp Hardware or any EXG sensor
BioPotentials	ECG
No. of channels	1
Wearable	Yes

5.3.3 3. Brain BioAmp Band

Brain BioAmp Band (EEG Band) is a stretchable band that can be connected to any of our Brain BioAmp Hardware or any EXG sensor using BioAmp Cable to record signals from the brain hassle-free.

Length	15.5 inches
Stretchability	2X (Upto 31 inches)
Usability	Reusable as it comes with washable fabric
Interface	Snap electrodes
Compatible Hardware	Brain BioAmp Hardware or any EXG sensor
BioPotentials	EEG
No. of channels	2 or 6
Wearable	Yes

You can get either a 2-channel or a 6-channel Brain BioAmp Band according to your project or research requirements:

2-Channel Brain BioAmp Band

It can be used to record EEG signals up to 2 channels either from the visual cortex (back of your head) or the prefrontal cortex part of brain.



6-Channel Brain BioAmp Band

It can be used to record EEG signals up to 2 channels either from the visual cortex (back of your head) or the prefrontal cortex part of brain.



5.4 Using Muscle BioAmp Band

5.4.1 Assembly

1. Take your Muscle BioAmp Band, hold the side of the band that has buckle on it and align the top part of the buckle with the flat surface of the snap.



1. Take the other end of the band and insert it in the buckle.
3. Your band is now ready to use. You can also adjust the size of the band according to your targeted muscle.

Take other end of the band and insert it in the buckle



Insert this end of the band into the buckle as shown and pull it to finish the assembly





5.4.2 Skin Preparation

Apply Nuprep Skin Preparation Gel on the skin surface where dry electrodes would be placed to remove dead skin cells and clean the skin from dirt. After rubbing the skin surface thoroughly, clean it with an alcohol wipe or a wet wipe.

For more information, please check out detailed step by step *Skin Preparation Guide*.

5.4.3 Measure EMG

1. Flip the band and snap the dry electrodes of the BioAmp Cable on it as shown below.

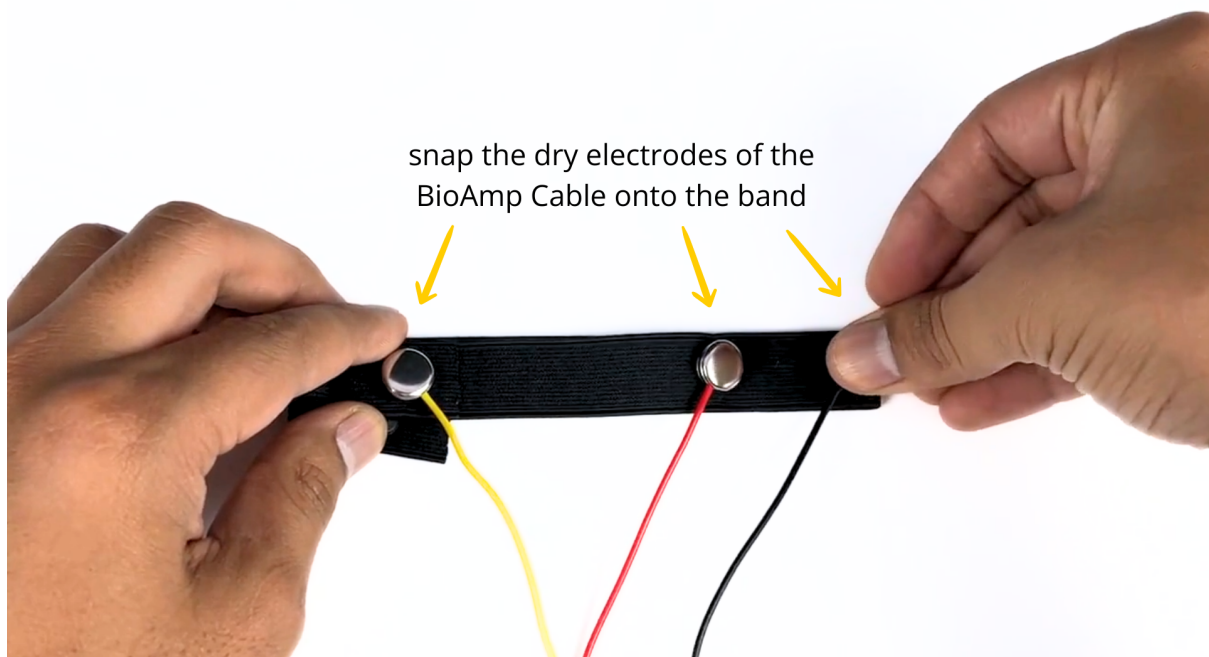

1. Flip the band again and wear it on your arm in such a way that IN+ and IN- are placed on the arm near the ulnar nerve and REF (reference) on the farther side of the band.

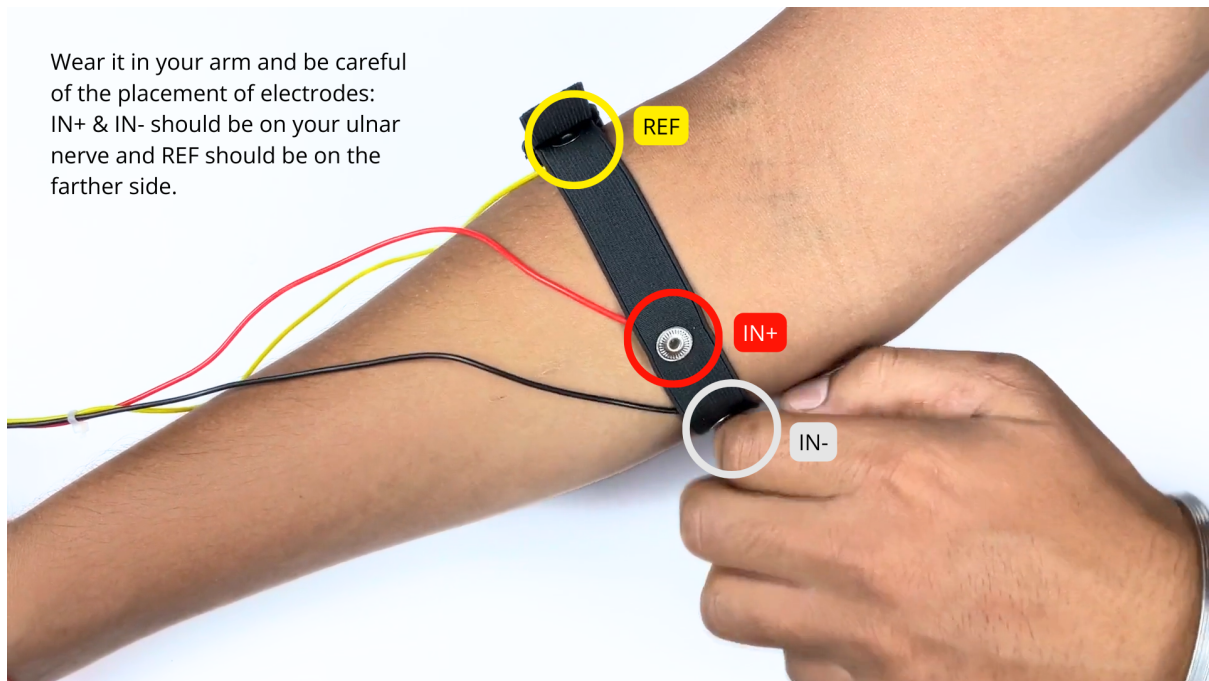
**Note**

Make sure the dry electrodes (shiny parts of the BioAmp Cable) are in direct contact with the skin.

3. Now put a small amount of electrode gel or Ten20 paste between the skin and dry electrodes to get the best signal acquisition.

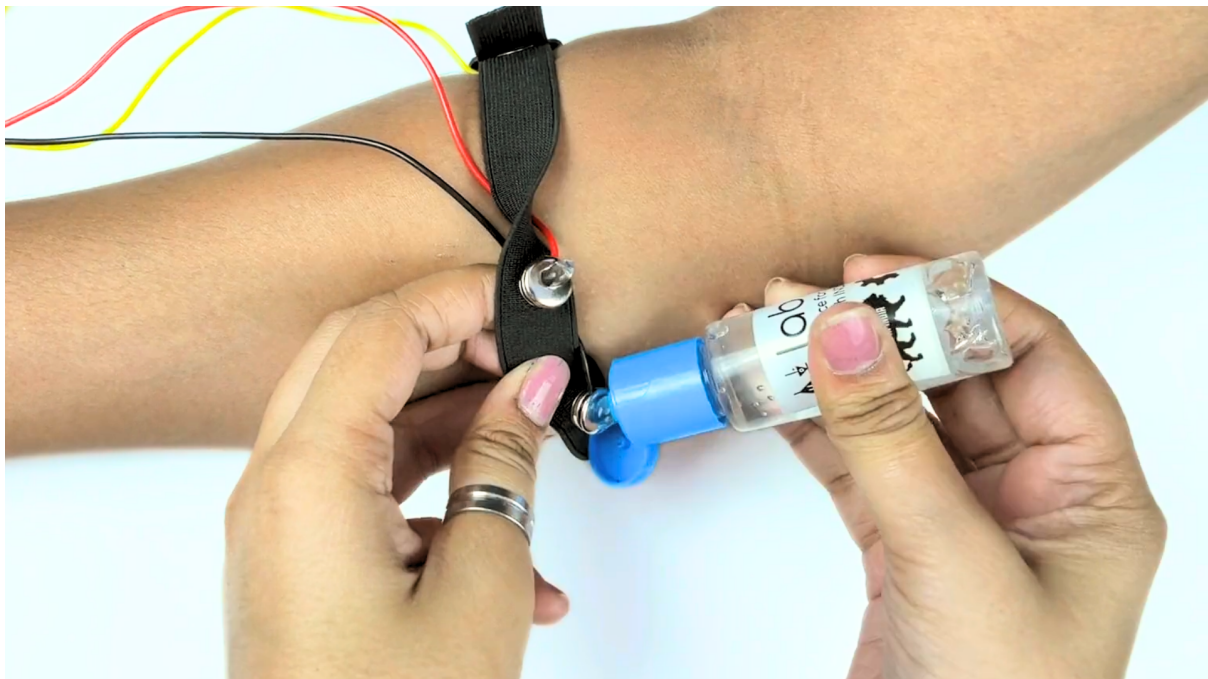

Note

- After using the band, don't leave the gel residue on the dry electrodes longer than an hour as it may corrode them over a period of time.
- Wash the band with liquid soap and rinse it properly after every use. Use it again only when it is completely dry.

5.5 Using Heart BioAmp Band

5.5.1 Skin Preparation

Apply Nuprep Skin Preparation Gel on your chest where dry electrodes would be placed to remove dead skin cells and clean the skin from dirt. After rubbing the skin surface thoroughly, clean it with an alcohol wipe or a wet wipe.

For more information, please check out detailed step by step *Skin Preparation Guide*.

5.5.2 Assembly

1. Take your Heart BioAmp Band and wrap the band around your chest in such a way that the pointy part of the snap touches your chest and the flat part is on the outer side.

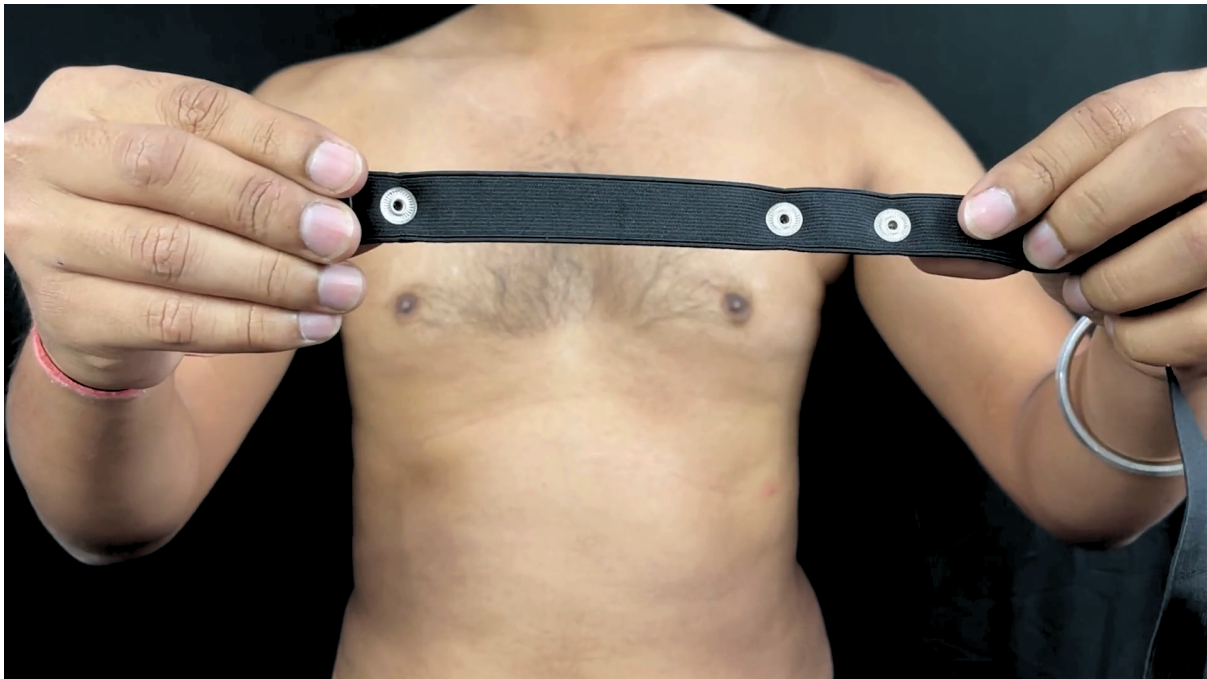

2. Now insert the loose end of the band into the buckle and tighten it by pulling the strap.
3. Your band is now ready to use. You can also adjust the size of the band according to your chest size.



5.5.3 Measure ECG

1. Snap the IN- cable on the left most side of the band, IN+ cable in the middle, and REF cable on the right side as shown below.

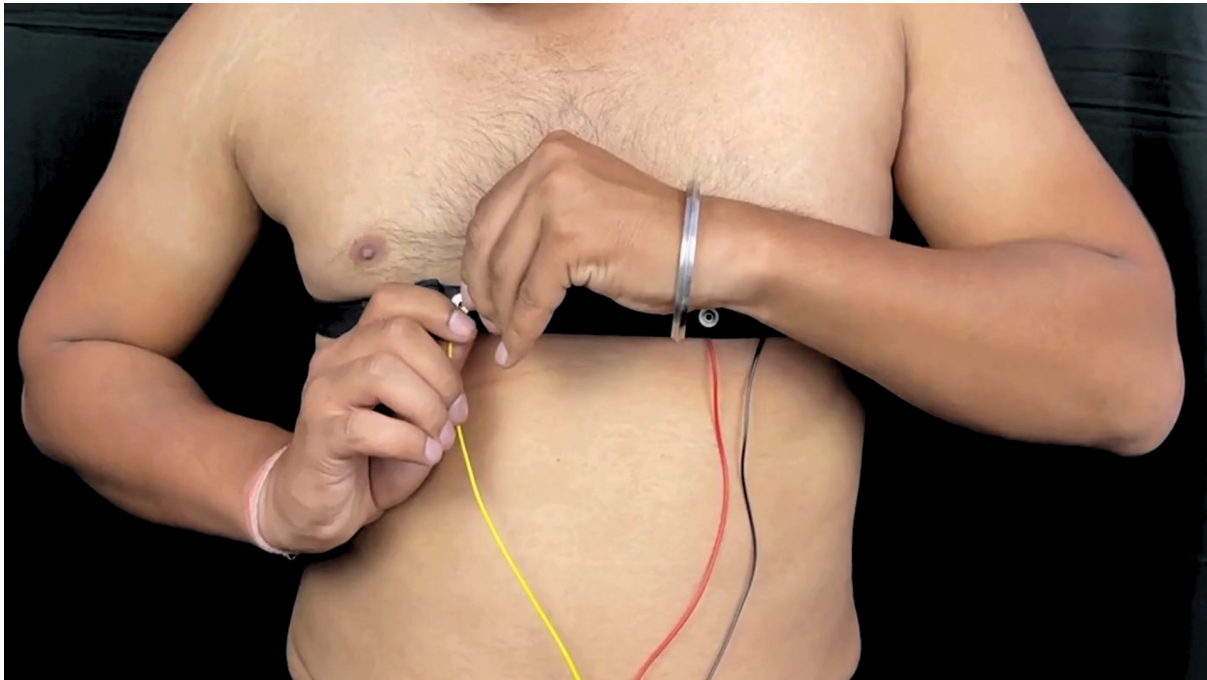

Note

Make sure the dry electrodes (shiny parts of the BioAmp Cable) are in direct contact with the skin.

2. Now put a small amount of electrode gel or Ten20 paste between the skin and dry electrodes to get the best signal acquisition.



Note

- After using the band, don't leave the gel residue on the dry electrodes longer than an hour as it may corrode them over a period of time.
- Wash the band with liquid soap and rinse it properly after every use. Use it again only when it is completely dry.

5.6 Using Brain BioAmp Band

5.6.1 Assembly

You get the band in two parts - the longer part consists of buckles at both ends and the shorter one has loose ends on both sides.

1. Hold one end of the longer band and align the top part of the buckle with the flat surface of the snap.
2. Now take the shorter band and insert it into the buckle of longer band.
3. Repeat step 1 and 2 for the other buckle on the longer band.
4. Your band is now ready to use. You can also adjust the size of the band according to your head size.

5.6.2 Skin Preparation

Apply Nuprep Skin Preparation Gel on your targeted area (visual cortex or prefrontal cortex) where dry electrodes would be placed to remove dead skin cells and clean the skin from dirt. After rubbing the skin surface thoroughly, clean it with an alcohol wipe or a wet wipe.

For more information, please check out detailed step by step *Skin Preparation Guide*.

5.6.3 Measure 1-channel EEG

1. Flip the band, take your BioAmp Cable, and snap the REF cable on a gel electrode. Now snap the IN- and IN+ cable on:
 - Fp1 and Fp2 positions for recording EEG from prefrontal cortex
 - O1 and O2 positions for recording EEG from visual cortex

Note

The electrode positions mentioned above are according to [International 10-20 system for recording EEG](#).

2. Flip the band again and wear it in a way so that the dry electrodes (shiny parts of the cable) are in contact with:
 - skin surface on the forehead (if recording from prefrontal cortex)
 - scalp surface on the back side of your head (if recording from visual cortex)
3. Peel of the plastic backing of the gel electrode and place it on the bony part behind your earlobe.

Note

While placing the gel electrodes on the skin, make sure to place the non-sticky tab of the electrode in the direction opposite to your hair growth. This allows you to remove the electrodes easily without pulling off much body hair.

4. Now put a small amount of electrode gel or Ten20 paste between the skin/scalp and dry electrodes to get the best signal acquisition.